

YOUNG 2.0

Less profiles for a clear and essential look. Easy cleaning.

Los perfiles ceden el protagonismo al cristal.

Estética minimalista y comodidad para el día a día.

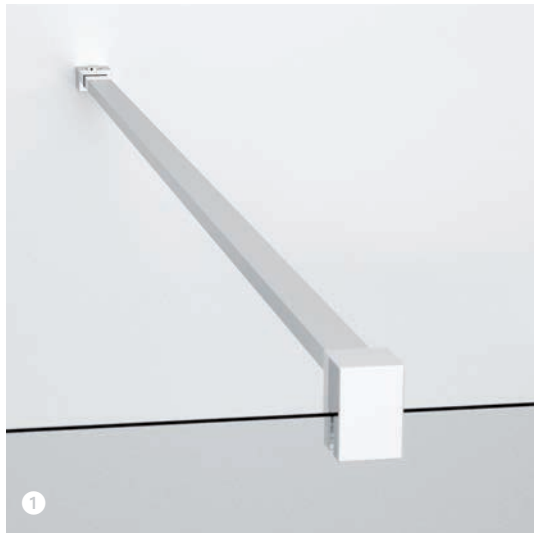

- 1 New support bar / Nueva barra de sujeción a pared
- 2 Chromed metal handle. / Tirador metálico cromo
- 3 Self Rising Hinges / Bisagra con sistema de autoelevación
- 4 In / Out opening of the door. / Sistemas de apertura interior / exterior

TREATMENT / TRATAMIENTOS



CRYSTAL CLEAR TREATMENT

Leaves glass easy to clean. Does not support the growth of bacteria and scale.

Only on transparent glass

TRATAMIENTO ANTIGOTAS

Dificulta la formación de gotas calcáreas. Cristaleses y perfiles siempre brillantes. Fácil de limpiar.

Sólo en cristal transparente.



PVD CHROME AND GOLD FINISH

Zero emission integrated cycle, 100% environment-friendly. Antiscale, antibacteria, ecological, long-time shining resistance.

ACABADO CROMO Y DORADO PVD

Ciclo de producción integrado sin emisiones, 100% ecológico. Anticalcáreo, Antibacterias, Ecológico. Brillo resistente y duradero.

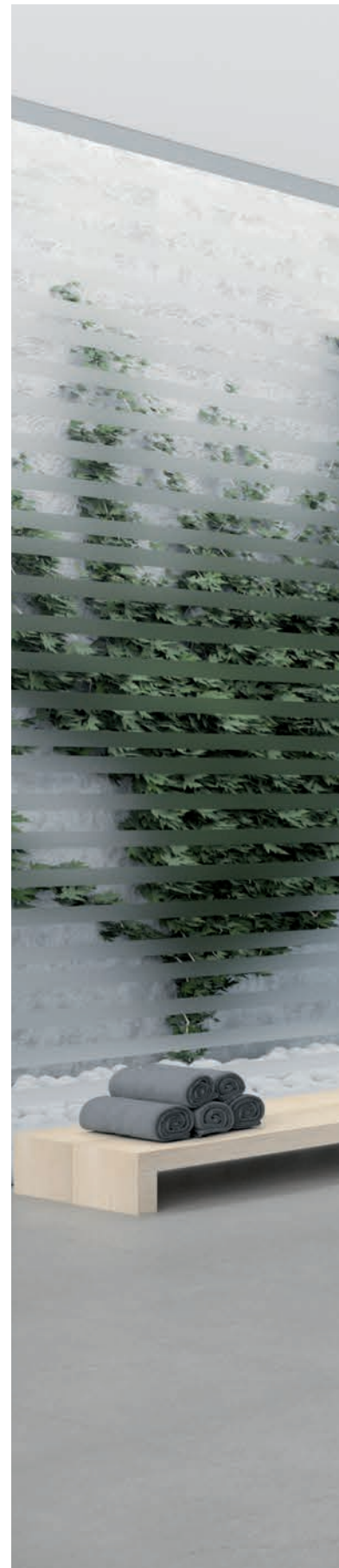

YOUNG 2.0 1B

HINGED SHOWER DOOR FOR RECESS INSTALLATION
MAMPARA DE UNA PUERTA ABATIBLE

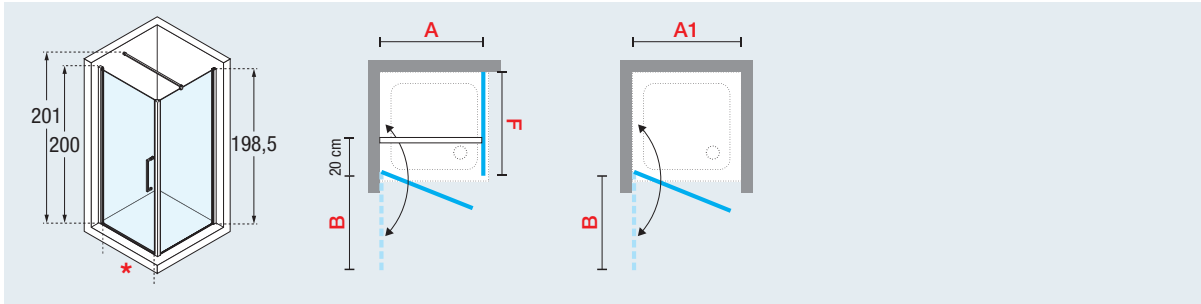

Dimensions Medidas				Code Código	Glass Cristales				Profile type / Price Perfiles / Precio			
Actual dimensions Extensibilidad		Access Entrada	Projection Espacio de apertura		1	2	4	72	D	B	K	O
With side panel Con fijo panel	For recess Entre paredes											

DOOR / PUERTA

A	A1	*	B	Code	Clear Transparente	Aqua	Satin Satinado	Victoriana Gold / Dorado	White Blanco	Silver	Chrome Cromo	Gold Dorado
58 ↔ 62	57 ↔ 61	47	48	Y2 1B 57-	●							
68 ↔ 72	67 ↔ 71	57	58	Y2 1B 67-	●							
73 ↔ 77	72 ↔ 76	62	63	Y2 1B 72-	●							
78 ↔ 82	77 ↔ 81	67	68	Y2 1B 77-	●							
88 ↔ 92	87 ↔ 91	77	78	Y2 1B 87-	●							
98 ↔ 102	97 ↔ 101	87	88	Y2 1B 97-	●							
H 140 ↓ 200 L 57 ↔ 99				SPECIAL	Y2 1B SP							

SIDE PANEL / FIJO PANEL

F	A	A1	*	B	Code	Clear Transparente	Aqua	Satin Satinado	Victoriana Gold / Dorado	White Blanco	Silver	Chrome Cromo	Gold Dorado
57 ↔ 59	-	-	-	-	Y2 F1B 57-								
59 ↔ 61	-	-	-	-	Y2 F1B 59-								
65 ↔ 67	-	-	-	-	Y2 F1B 65-								
67 ↔ 69	-	-	-	-	Y2 F1B 67-	●							
69 ↔ 71	-	-	-	-	Y2 F1B 69-								
73 ↔ 75	-	-	-	-	Y2 F1B 73-								
75 ↔ 77	-	-	-	-	Y2 F1B 75-								
77 ↔ 79	-	-	-	-	Y2 F1B 77-	●							
79 ↔ 81	-	-	-	-	Y2 F1B 79-								
85 ↔ 87	-	-	-	-	Y2 F1B 85-								
87 ↔ 89	-	-	-	-	Y2 F1B 87-	●							
89 ↔ 91	-	-	-	-	Y2 F1B 89-	●							
95 ↔ 97	-	-	-	-	Y2 F1B 95-								
97 ↔ 99	-	-	-	-	Y2 F1B 97-	●							
99 ↔ 101	-	-	-	-	Y2 F1B 99-								
117 ↔ 119	-	-	-	-	Y2 F1B 117-								
119 ↔ 121	-	-	-	-	Y2 F1B 119-								
* H 140 ↓ 200 L 20 ↔ 120				SPECIAL	Y2 F1B SP								

HOW TO CHOOSE YOUR PRODUCT USING THE CODES:
EJEMPLO DE CÓDIGO:

Y21B57-1D	=	Y21B57-	+	1	+	D
-----------	---	---------	---	---	---	---

- * Special side panel must be ordered the same height of the door
- * El fijo especial debe ser de la misma altura que la puerta

● In stock - Delivery within 7 business days
Stock disponible - Entrega en un plazo máximo de 7 días





200 cm



6 mm



Door
Puerta
4 cm



Side Panel
Fijo panel
2 cm



p. 47



IN / OUT OPENING OF THE DOOR
APERTURA INTERIOR - EXTERIOR



OPTIONAL / OPCIONAL



Support bar
Barra estabilizadora en ángulo

Dimensions <i>Medidas</i>	Code <i>Código</i>	Price / <i>Precio</i>	
		Chrome <i>Cromo</i>	Gold <i>Dorado</i>
15 cm	R80LOU150-	K	O
25 cm	R80LOU250-		
35 cm	R80LOU350-		
45 cm	R80LOU450-		

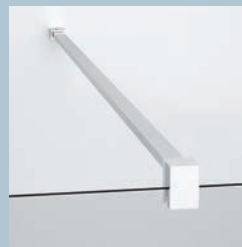

Support bar 150 cm length
Barra de sujeción 150 cm

Profile <i>Color perfil</i>	Code <i>Código</i>	Price <i>Precio</i>
White <i>Blanco</i>	R80Y215-D	
Silver	R80Y215-B	
Chrome <i>Cromo</i>	R80Y215-K	
Gold <i>Dorado</i>	R80Y215-O	



Adjustable bar kit

- 1 adjustable bar of 100 cm (shortened)
- wall attachment
- 1 glass clamp

Kit barra orientable

- Barra de 100 cms
- Pieza sujeción a muro
- Pieza de fijación al cristal

Profile <i>Color perfil</i>	Code <i>Código</i>	Price <i>Precio</i>
White <i>Blanco</i>	R80KUOR100-D	
Silver	R80KUOR100-B	
Chrome <i>Cromo</i>	R80KUOR100-K	



"T" bar kit

support bar of 150 cm to match with the supplied bar for T solution

Kit de barra en "T"

barra de sujeción de 150 cm para instalación en "T"

Profile <i>Color perfil</i>	Code <i>Código</i>	Price <i>Precio</i>
White <i>Blanco</i>	R80Y215T-D	
Silver	R80Y215T-B	
Chrome <i>Cromo</i>	R80Y215T-K	
Gold <i>Dorado</i>	R80Y215T-O	

TECHNICAL DATA / DATOS TÉCNICOS

GLASS TYPES / CRISTAL (EUROPEAN STANDARDS UNI EN 14428)

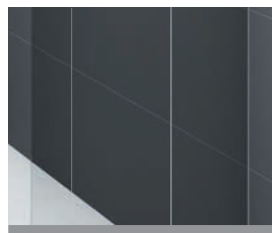

Clear
Transparente
COD. 1



Aqua
COD. 2

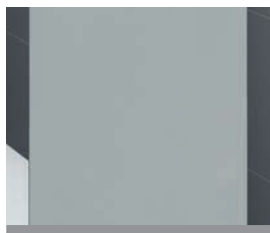

Satin
Satinado
COD. 4

PRINTING / SERIGRAFIA

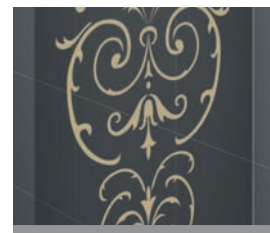

Victoriana Gold
Victoriana Dorado
COD. 72

(only for / solo para 2G, G+F, 1B, R2 LUX)

PROFILE COLOURS / COLORES PERFILES



White
Blanco
COD. D



Silver
COD. B



Chrome
Cromo
COD. K

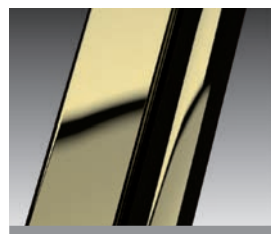

Gold
Dorado
COD. O



(only for / solo para 2G, G+F, 2A, 2B, F2B, G+F in line / en línea, 1B, F1B, A, R, R2, R1 SWIM, R2 LUX)

HANDLES / TIRADOR



Chromed metal handles
Tirador cromo
Interaxis 384mm
Medida entre agujeros de 384 mm

OVERALL DIMENSIONS FIXING PROFILES / MEDIDAS QUE OCUPAN LOS PERFILES EN LA PARED

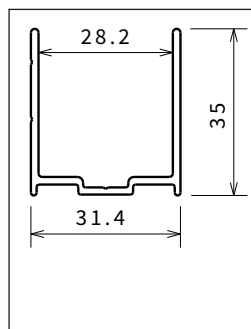

WALL / A PARED

Height Altura	Profile Color perfil	Code Código
1984	White / Blanco	P01BNMOBST-A
1984	Silver	P01BNMOBST-B
1984	Chrome / Cromo	P01BNMOBST-K
1984	Gold / Dorado	P01BNMOBST-O
2000	White / Blanco	P01BNMOAST-A
2000	Silver	P01BNMOAST-B
2000	Chrome / Cromo	P01BNMOAST-K
2000	Gold / Dorado	P01BNMOAST-O

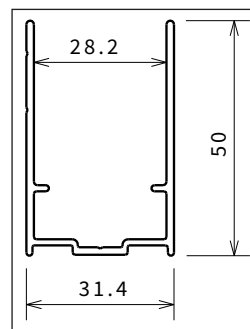

COMPENSATORY / COMPENSADORES

Height Altura	Profile Color perfil	Code Código
1984	White / Blanco	P05Y2ST-A
1984	Silver	P05Y2ST-B
1984	Chrome / Cromo	P05Y2ST-K
1984	Gold / Dorado	P05Y2ST-O
2000	White / Blanco	P05Y2ST2-A
2000	Silver	P05Y2ST2-B
2000	Chrome / Cromo	P05Y2ST2-K
2000	Gold / Dorado	P05Y2ST2-O

HOW TO TAKE THE MEASUREMENT / TOMA DE MEDIDAS

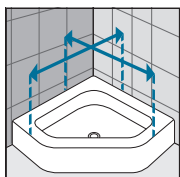
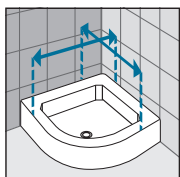
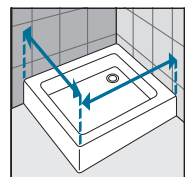

Take the measurements from wall to the external edge of the shower tray. Dimensions must be taken once the walls are finished and tiled, according to the above drawings.

Tomar las medidas desde la pared hasta el borde externo del plato de ducha.

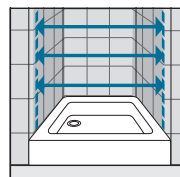

Take the measurements from wall to wall at the bottom, at the top, in the middle and use the smallest. Dimensions must be taken once the walls are finished and tiled, according to the above drawings.

Tomar medidas de pared a pared, medir la parte baja, la central y la superior. Cursar el pedido con la medida más pequeña.

YOUNG 2.0

Less profiles for a clear and essential look. Easy cleaning.

Los perfiles ceden el protagonismo al cristal.

Estética minimalista y comodidad para el día a día.

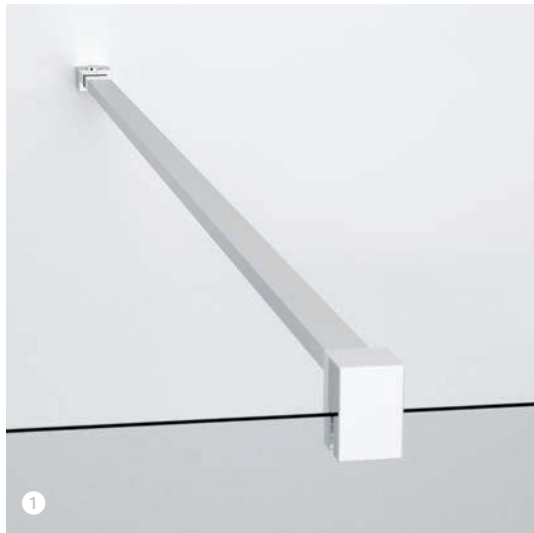

- ① New support bar / Nueva barra de sujeción a pared
- ② Chromed metal handle. / Tirador metálico cromo
- ③ Self Rising Hinges / Bisagra con sistema de autoelevación
- ④ In / Out opening of the door. / Sistemas de apertura interior / exterior

TREATMENT / TRATAMIENTOS



CRYSTAL CLEAR TREATMENT

Leaves glass easy to clean. Does not support the growth of bacteria and scale.

Only on transparent glass

TRATAMIENTO ANTIGOTAS

Dificulta la formación de gotas calcáreas. Cristaleses y perfiles siempre brillantes. Fácil de limpiar.

Sólo en cristal transparente.



PVD CHROME AND GOLD FINISH

Zero emission integrated cycle, 100% environment-friendly. Antiscale, antibacteria, ecological, long-time shining resistance.

ACABADO CROMO Y DORADO PVD

Ciclo de producción integrado sin emisiones, 100% ecológico. Anticalcáreo, Antibacterias, Ecológico. Brillo resistente y duradero.

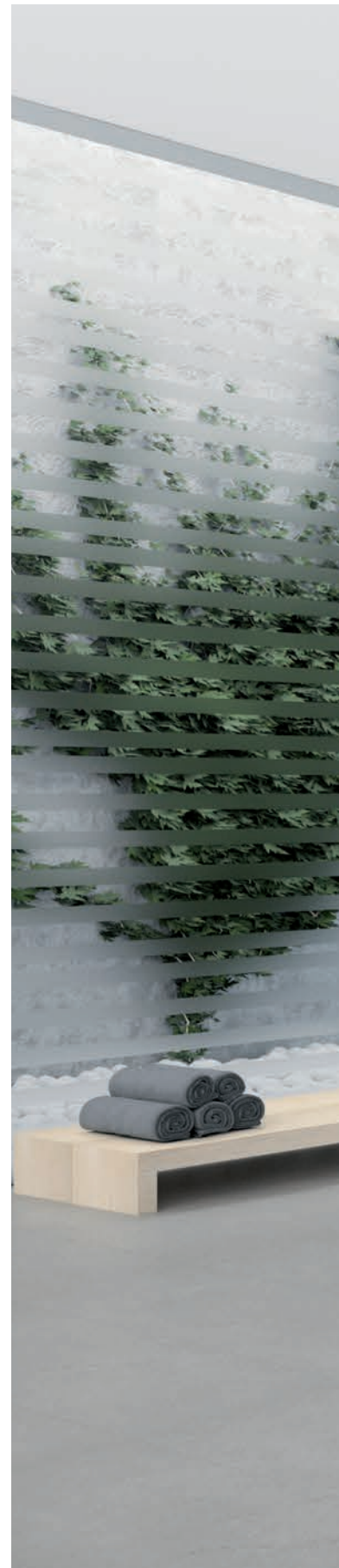

YOUNG 2.0 1BS

SHOWER DOOR, 1 HINGED FOLDING DOOR FOR RECESS INSTALLATION
FRONTAL PLEGABLE SIN GUIAS

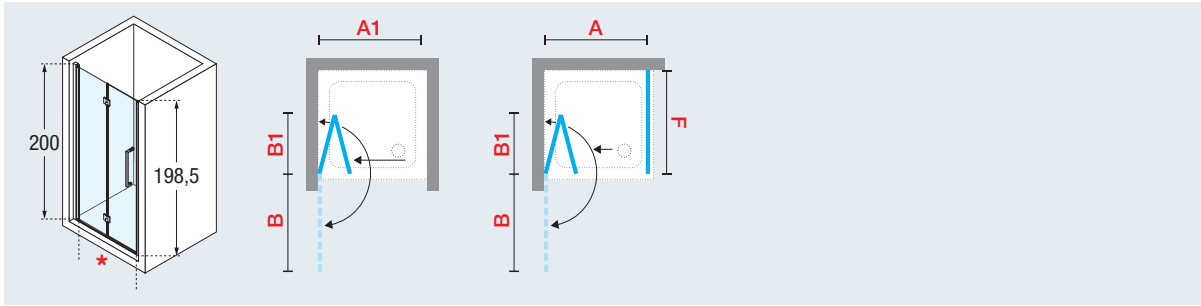

Dimensions Medidas			Code Código	Left Izquierda	Right Derecha	Glass Cristales			Profile type / Price Perfiles / Precio		
Actual dimensions Extensibilidad	Access Entrada	Projection Espacio de apertura		S-	D-	1	2	4	D	B	K
With side panel Con fijo panel	For recess Entre paredes										

DOOR / PUERTA

A	A1	*	B	B1	Code	Clear Transparente	Aqua	Satin Satinado	White Blanco	Silver	Chrome Cromo
58 ↔ 62	57 ↔ 61	41	47	23,6	Y2 1BS 57	●					
68 ↔ 72	67 ↔ 71	51	57	28,6	Y2 1BS 67	●					
73 ↔ 77	72 ↔ 76	56	62	31,1	Y2 1BS 72	●					
78 ↔ 82	77 ↔ 81	61	67	33,6	Y2 1BS 77	●					
88 ↔ 92	87 ↔ 91	71	77	38,6	Y2 1BS 87	●					
98 ↔ 102	97 ↔ 101	81	87	43,6	Y2 1BS 97	●					
118 ↔ 122	117 ↔ 121	101	107	53,6	Y2 1BS 117	●					

SIDE PANEL / FIJO PANEL

F	Code	Clear Transparente	Aqua	Satin Satinado	White Blanco	Silver	Chrome Cromo
57 ↔ 59	Y2 F1B 57-						
59 ↔ 61	Y2 F1B 59-						
65 ↔ 67	Y2 F1B 65-						
67 ↔ 69	Y2 F1B 67-	●					
69 ↔ 71	Y2 F1B 69-						
73 ↔ 75	Y2 F1B 73-						
75 ↔ 77	Y2 F1B 75-						
77 ↔ 79	Y2 F1B 77-	●					
79 ↔ 81	Y2 F1B 79-						
85 ↔ 87	Y2 F1B 85-						
87 ↔ 89	Y2 F1B 87-	●					
89 ↔ 91	Y2 F1B 89-	●					
95 ↔ 97	Y2 F1B 95-						
97 ↔ 99	Y2 F1B 97-						
99 ↔ 101	Y2 F1B 99-	●					
117 ↔ 119	Y2 F1B 117-						
119 ↔ 121	Y2 F1B 119-						

* H 140 ↓ 200 L 20 ↔ 120 SPECIAL Y2 F1B SP

HOW TO CHOOSE YOUR PRODUCT USING THE CODES:
EJEMPLO DE CÓDIGO:

Y21BS57S-1D = Y21BS57 + S- + 1 + D

- * Special side panel must be ordered the same height of the door
- * El fijo especial debe ser de la misma altura que la puerta

● In stock - Delivery within 7 business days
Stock disponible - Entrega en un plazo máximo de 7 días

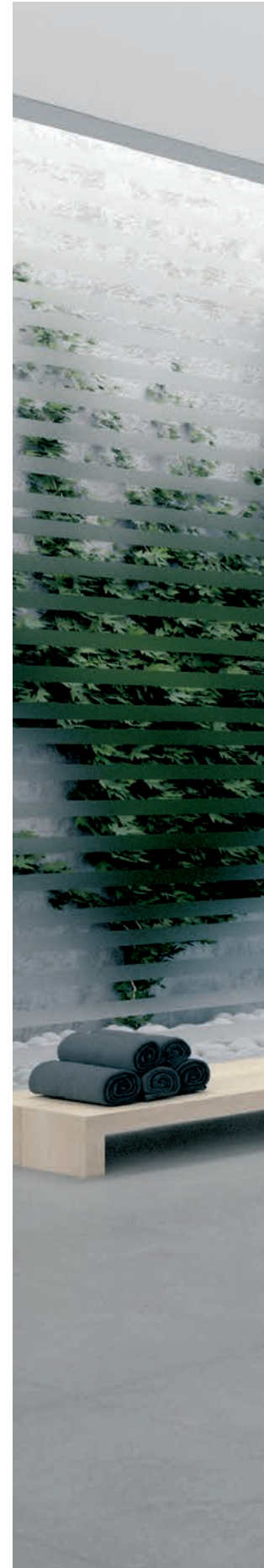



200 cm



6 mm



Door
Puerta
4 cm



Side panel
Fijo panel
2 cm



Door
Puerta



Side panel
Fijo panel



p. 47





OPTIONAL / OPCIONAL



Support bar
Barra estabilizadora en ángulo

Dimensions <i>Medidas</i>	Code <i>Código</i>	Price / Precio	
		Chrome <i>Cromo</i>	Gold <i>Dorado</i>
15 cm	R80LOU150-	K	O
25 cm	R80LOU250-		
35 cm	R80LOU350-		
45 cm	R80LOU450-		

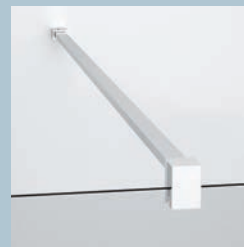

Support bar 150 cm length
Barra de sujeción 150 cm

Profile <i>Color perfil</i>	Code <i>Código</i>	Price <i>Precio</i>
White <i>Blanco</i>	R80Y215-D	
Silver	R80Y215-B	
Chrome <i>Cromo</i>	R80Y215-K	
Gold <i>Dorado</i>	R80Y215-O	



Adjustable bar kit

- 1 adjustable bar of 100 cm (shortened)
- wall attachment
- 1 glass clamp

Kit barra orientable

- Barra de 100 cms
- Pieza sujeción a muro
- Pieza de fijación al cristal

Profile <i>Color perfil</i>	Code <i>Código</i>	Price <i>Precio</i>
White <i>Blanco</i>	R80KUOR100-D	
Silver	R80KUOR100-B	
Chrome <i>Cromo</i>	R80KUOR100-K	



"T" bar kit

support bar of 150 cm to match with the supplied bar for T solution

Kit de barra en "T"

barra de sujeción de 150 cm para instalación en "T"

Profile <i>Color perfil</i>	Code <i>Código</i>	Price <i>Precio</i>
White <i>Blanco</i>	R80Y215T-D	
Silver	R80Y215T-B	
Chrome <i>Cromo</i>	R80Y215T-K	
Gold <i>Dorado</i>	R80Y215T-O	

TECHNICAL DATA / DATOS TÉCNICOS

GLASS TYPES / CRISTAL (EUROPEAN STANDARDS UNI EN 14428)

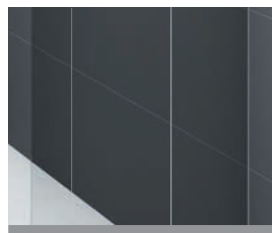

Clear
Transparente
COD. 1



Aqua
COD. 2

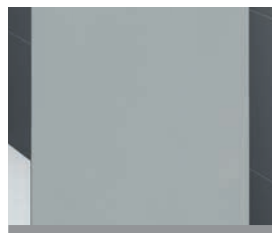

Satin
Satinado
COD. 4

PRINTING / SERIGRAFIA

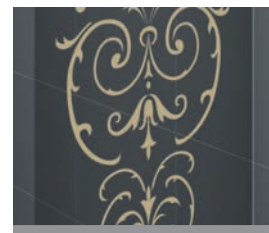

Victoriana Gold
Victoriana Dorado
COD. 72

(only for / solo para 2G, G+F, 1B, R2 LUX)

PROFILE COLOURS / COLORES PERFILES



White
Blanco
COD. D



Silver
COD. B



Chrome
Cromo
COD. K

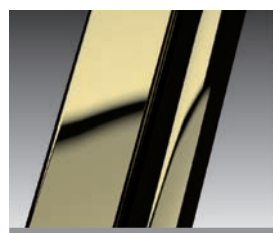

Gold
Dorado
COD. O



(only for / solo para 2G, G+F, 2A, 2B, F2B, G+F in line / en línea, 1B, F1B, A, R, R2, R1 SWIM, R2 LUX)

HANDLES / TIRADOR



Chromed metal handles
Tirador cromo
Interaxis 384mm
Medida entre agujeros de 384 mm

OVERALL DIMENSIONS FIXING PROFILES / MEDIDAS QUE OCUPAN LOS PERFILES EN LA PARED

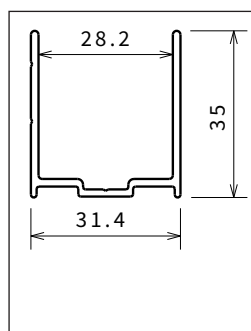

WALL / A PARED

Height Altura	Profile Color perfil	Code Código
1984	White / Blanco	P01BNMOBST-A
1984	Silver	P01BNMOBST-B
1984	Chrome / Cromo	P01BNMOBST-K
1984	Gold / Dorado	P01BNMOBST-O
2000	White / Blanco	P01BNMOAST-A
2000	Silver	P01BNMOAST-B
2000	Chrome / Cromo	P01BNMOAST-K
2000	Gold / Dorado	P01BNMOAST-O

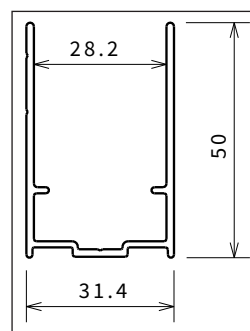

COMPENSATORY / COMPENSADORES

Height Altura	Profile Color perfil	Code Código
1984	White / Blanco	P05Y2ST-A
1984	Silver	P05Y2ST-B
1984	Chrome / Cromo	P05Y2ST-K
1984	Gold / Dorado	P05Y2ST-O
2000	White / Blanco	P05Y2ST2-A
2000	Silver	P05Y2ST2-B
2000	Chrome / Cromo	P05Y2ST2-K
2000	Gold / Dorado	P05Y2ST2-O

HOW TO TAKE THE MEASUREMENT / TOMA DE MEDIDAS

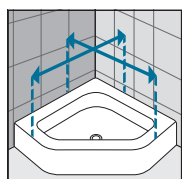
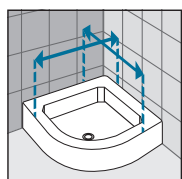
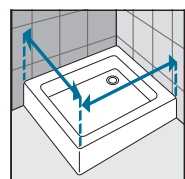

Take the measurements from wall to the external edge of the shower tray. Dimensions must be taken once the walls are finished and tiled, according to the above drawings.

Tomar las medidas desde la pared hasta el borde externo del plato de ducha.

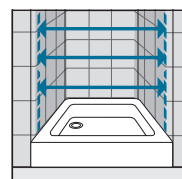

Take the measurements from wall to wall at the bottom, at the top, in the middle and use the smallest. Dimensions must be taken once the walls are finished and tiled, according to the above drawings.

Tomar medidas de pared a pared, medir la parte baja, la central y la superior. Cursar el pedido con la medida más pequeña.

YOUNG 2.0

Less profiles for a clear and essential look. Easy cleaning.

Los perfiles ceden el protagonismo al cristal.

Estética minimalista y comodidad para el día a día.



- ① New support bar / Nueva barra de sujeción a pared
- ② Chromed metal handle. / Tirador metálico cromo
- ③ Self Rising Hinges / Bisagra con sistema de autoelevación
- ④ In / Out opening of the door. / Sistemas de apertura interior / exterior

TREATMENT / TRATAMIENTOS



CRYSTAL CLEAR TREATMENT

Leaves glass easy to clean. Does not support the growth of bacteria and scale.

Only on transparent glass

TRATAMIENTO ANTIGOTAS

Dificulta la formación de gotas calcáreas. Cristaleses y perfiles siempre brillantes. Fácil de limpiar.

Sólo en cristal transparente.



PVD CHROME AND GOLD FINISH

Zero emission integrated cycle, 100% environment-friendly. Antiscala, antibacteria, ecological, long-time shining resistance.

ACABADO CROMO Y DORADO PVD

Ciclo de producción integrado sin emisiones, 100% ecológico. Anticalcáreo, Antibacterias, Ecológico. Brillo resistente y duradero.

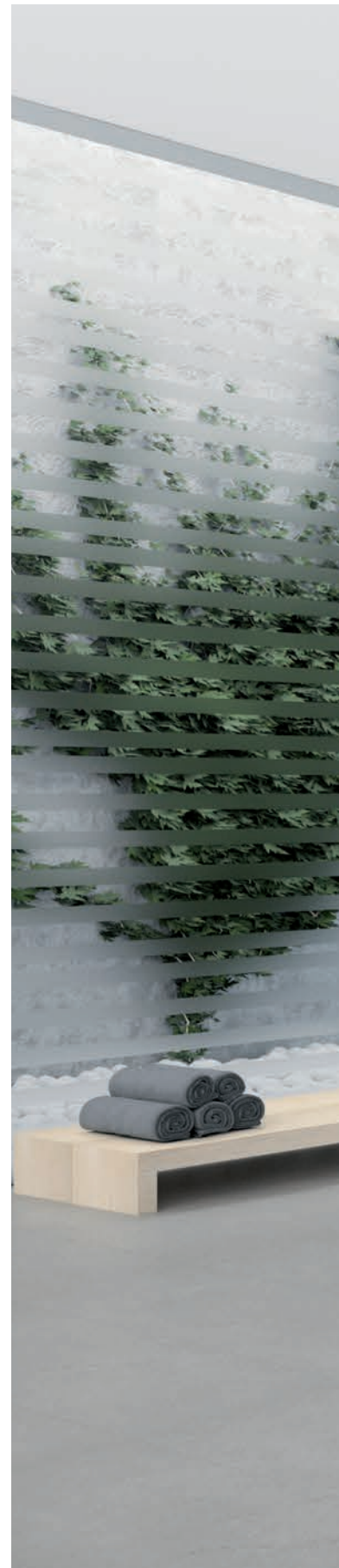

YOUNG 2.0 2A



SHOWER DOOR, 2 HINGED DOORS + 2 FIXED PANELS IN LINE, FOR RECESS INSTALLATION
FRONTAL DE DOS HOJAS ABATIBLES + DOS FIJOS

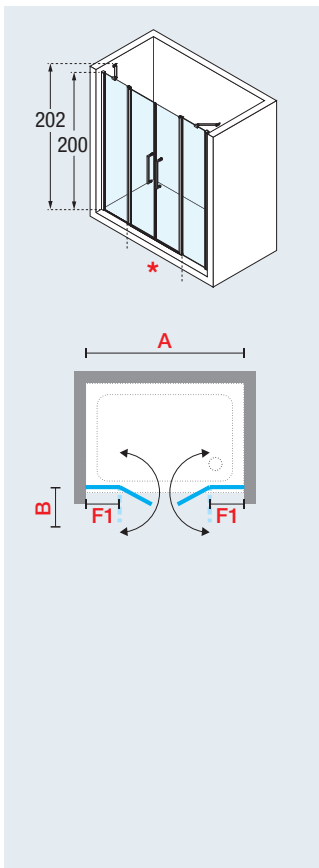

Dimensions Medidas				Code Código	Glass Cristales			Profile type / Price Perfiles / Precio			
Actual dimensions Extensibilidad	Access Entrada	Projection Espacio de apertura			1	2	4	D	B	K	O
A	F1	*	B		Clear Transparente	Aqua	Satin Satinado	White Blanco	Silver	Chrome Cromo	Gold Dorado
97 ↔ 101	25	43	22	Y2 2A 97-							
117 ↔ 121	30	53	27	Y2 2A 117-							
137 ↔ 141	36	61	31	Y2 2A 137-							
147 ↔ 151	37	69	35	Y2 2A 147-							
157 ↔ 161	40	73	37	Y2 2A 157-							
167 ↔ 171	43	77	39	Y2 2A 167-							
177 ↔ 181	45	81	41	Y2 2A 177-							

HOW TO CHOOSE YOUR PRODUCT USING THE CODES:
EJEMPLO DE CÓDIGO:



● In stock - Delivery within 7 business days
Stock disponible - Entrega en un plazo máximo de 7 días



OPTIONAL / OPCIONAL



Support bar
Barra estabilizadora en ángulo

Dimensions <i>Medidas</i>	Code <i>Código</i>	Price / <i>Precio</i>	
		Chrome <i>Cromo</i>	Gold <i>Dorado</i>
15 cm	R80LOU150-	K	O
25 cm	R80LOU250-		
35 cm	R80LOU350-		
45 cm	R80LOU450-		

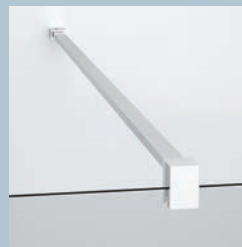

Support bar 150 cm length
Barra de sujeción 150 cm

Profile <i>Color perfil</i>	Code <i>Código</i>	Price <i>Precio</i>
White <i>Blanco</i>	R80Y215-D	
Silver	R80Y215-B	
Chrome <i>Cromo</i>	R80Y215-K	
Gold <i>Dorado</i>	R80Y215-O	



Adjustable bar kit

- 1 adjustable bar of 100 cm (shortened)
- wall attachment
- 1 glass clamp

Kit barra orientable

- Barra de 100 cms
- Pieza sujeción a muro
- Pieza de fijación al cristal

Profile <i>Color perfil</i>	Code <i>Código</i>	Price <i>Precio</i>
White <i>Blanco</i>	R80KUOR100-D	
Silver	R80KUOR100-B	
Chrome <i>Cromo</i>	R80KUOR100-K	



"T" bar kit

support bar of 150 cm to match with the supplied bar for T solution

Kit de barra en "T"

barra de sujeción de 150 cm para instalación en "T"

Profile <i>Color perfil</i>	Code <i>Código</i>	Price <i>Precio</i>
White <i>Blanco</i>	R80Y215T-D	
Silver	R80Y215T-B	
Chrome <i>Cromo</i>	R80Y215T-K	
Gold <i>Dorado</i>	R80Y215T-O	

TECHNICAL DATA / DATOS TÉCNICOS

GLASS TYPES / CRISTAL (EUROPEAN STANDARDS UNI EN 14428)



Clear
Transparente
COD. 1



Aqua
COD. 2

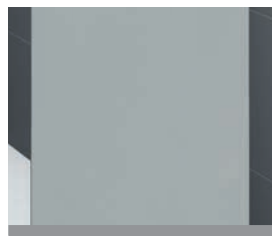

Satin
Satinado
COD. 4

PRINTING / SERIGRAFIA

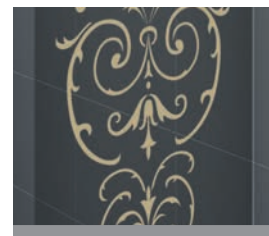

Victoriana Gold
Victoriana Dorado
COD. 72

(only for / solo para 2G, G+F, 1B, R2 LUX)

PROFILE COLOURS / COLORES PERFILES



White
Blanco
COD. D



Silver
COD. B



Chrome
Cromo
COD. K

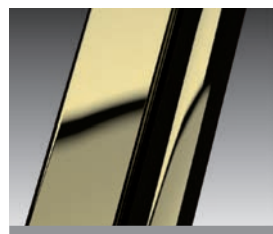

Gold
Dorado
COD. O



(only for / solo para 2G, G+F, 2A, 2B, F2B, G+F in line / en línea, 1B, F1B, A, R, R2, R1 SWIM, R2 LUX)

HANDLES / TIRADOR



Chromed metal handles
Tirador cromo
Interaxis 384mm
Medida entre agujeros de 384 mm

OVERALL DIMENSIONS FIXING PROFILES / MEDIDAS QUE OCUPAN LOS PERFILES EN LA PARED

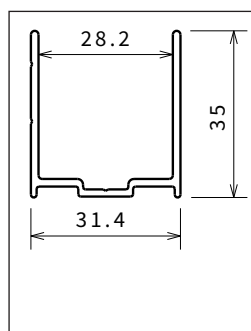

WALL / A PARED

Height Altura	Profile Color perfil	Code Código
1984	White / Blanco	P01BNMOBST-A
1984	Silver	P01BNMOBST-B
1984	Chrome / Cromo	P01BNMOBST-K
1984	Gold / Dorado	P01BNMOBST-O
2000	White / Blanco	P01BNMOAST-A
2000	Silver	P01BNMOAST-B
2000	Chrome / Cromo	P01BNMOAST-K
2000	Gold / Dorado	P01BNMOAST-O

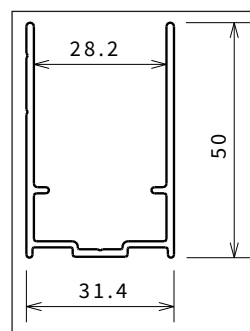

COMPENSATORY / COMPENSADORES

Height Altura	Profile Color perfil	Code Código
1984	White / Blanco	P05Y2ST-A
1984	Silver	P05Y2ST-B
1984	Chrome / Cromo	P05Y2ST-K
1984	Gold / Dorado	P05Y2ST-O
2000	White / Blanco	P05Y2ST2-A
2000	Silver	P05Y2ST2-B
2000	Chrome / Cromo	P05Y2ST2-K
2000	Gold / Dorado	P05Y2ST2-O

HOW TO TAKE THE MEASUREMENT / TOMA DE MEDIDAS

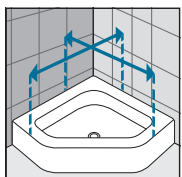
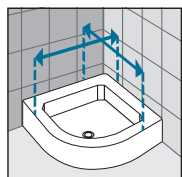
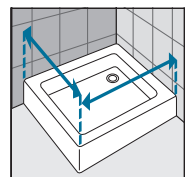

Take the measurements from wall to the external edge of the shower tray. Dimensions must be taken once the walls are finished and tiled, according to the above drawings.

Tomar las medidas desde la pared hasta el borde externo del plato de ducha.

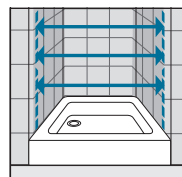

Take the measurements from wall to wall at the bottom, at the top, in the middle and use the smallest. Dimensions must be taken once the walls are finished and tiled, according to the above drawings.

Tomar medidas de pared a pared, medir la parte baja, la central y la superior. Cursar el pedido con la medida más pequeña.

YOUNG 2.0

Less profiles for a clear and essential look. Easy cleaning.

Los perfiles ceden el protagonismo al cristal.

Estética minimalista y comodidad para el día a día.

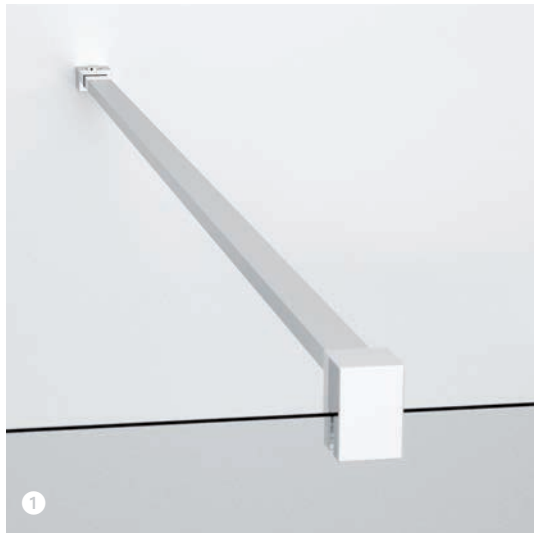

- 1 New support bar / Nueva barra de sujeción a pared
- 2 Chromed metal handle. / Tirador metálico cromo
- 3 Self Rising Hinges / Bisagra con sistema de autoelevación
- 4 In / Out opening of the door. / Sistemas de apertura interior / exterior

TREATMENT / TRATAMIENTOS



CRYSTAL CLEAR TREATMENT

Leaves glass easy to clean. Does not support the growth of bacteria and scale.

Only on transparent glass

TRATAMIENTO ANTIGOTAS

Dificulta la formación de gotas calcáreas. Cristaleses y perfiles siempre brillantes. Fácil de limpiar.

Sólo en cristal transparente.



PVD CHROME AND GOLD FINISH

Zero emission integrated cycle, 100% environment-friendly. Antiscale, antibacteria, ecological, long-time shining resistance.

ACABADO CROMO Y DORADO PVD

Ciclo de producción integrado sin emisiones, 100% ecológico. Anticalcáreo, Antibacterias, Ecológico. Brillo resistente y duradero.

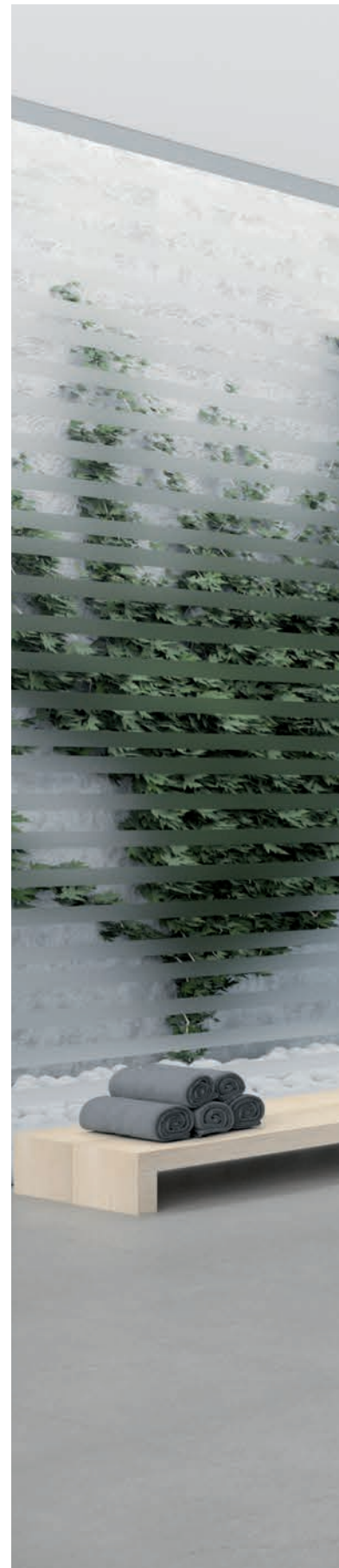

YOUNG 2.0 2B



200 cm



6 mm



4 cm



p. 47

SALOON TYPE SHOWER DOOR, 2 HINGED DOORS,
for recess installation or combined with a fix side Young 2.0 F2B

MAMPARA DE DOS HOJAS ABATIBLES

Para instalar entre paredes o con fijo lateral YOUNG 2.0 F2B

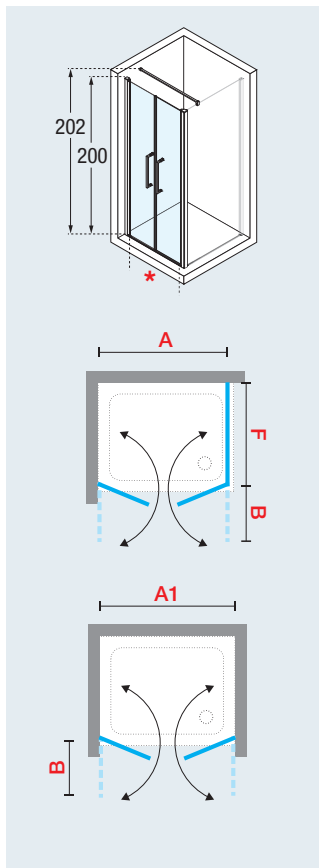

Dimensions Medidas				Code Código	Glass Cristales			Profile type / Price Perfiles / Precio			
Actual dimensions Extensibilidad		Access Entrada	Projection Espacio de apertura		1	2	4	D	B	K	O
With side panel Con fijo panel	For recess Entre paredes										
A	A1	*	B		Clear Transparente	Aqua	Satin Satinado	White Blanco	Silver	Chrome Cromo	Gold Dorado
58 ↔ 62	57 ↔ 61	45	23	Y2 2B 57-	●						
64 ↔ 68	63 ↔ 67	51	26	Y2 2B 63-							
68 ↔ 72	67 ↔ 71	55	28	Y2 2B 67-							
72 ↔ 76	71 ↔ 75	59	30	Y2 2B 71-							
74 ↔ 78	73 ↔ 77	61	31	Y2 2B 73-							
78 ↔ 82	77 ↔ 81	65	33	Y2 2B 77-	●						
84 ↔ 88	83 ↔ 87	71	36	Y2 2B 83-							
88 ↔ 92	87 ↔ 91	75	38	Y2 2B 87-	●						
94 ↔ 98	93 ↔ 97	81	41	Y2 2B 93-	●						
98 ↔ 102	97 ↔ 101	85	43	Y2 2B 97-	●						
104 ↔ 108	103 ↔ 107	91	46	Y2 2B 103-	●						
108 ↔ 112	107 ↔ 111	95	48	Y2 2B 107-	●						
114 ↔ 118	113 ↔ 117	101	51	Y2 2B 113-							
118 ↔ 122	117 ↔ 121	105	53	Y2 2B 117-							
138 ↔ 142	137 ↔ 141	125	63	Y2 2B 137-							
148 ↔ 152	147 ↔ 151	135	68	Y2 2B 147-							
158 ↔ 162	157 ↔ 161	145	73	Y2 2B 157-							
168 ↔ 172	167 ↔ 171	155	78	Y2 2B 167-							
178 ↔ 182	177 ↔ 181	165	83	Y2 2B 177-	●						
H 140 ↓ 200 L 57 ↔ 177				SPECIAL Y2 2B SP							

HOW TO CHOOSE YOUR PRODUCT USING THE CODES:
EJEMPLO DE CÓDIGO:

Y22B57-1D

=

Y22B57-

+

1

+

D

● In stock - Delivery within 7 business days
Stock disponible - Entrega en un plazo máximo de 7 días

YOUNG 2.0 F2B

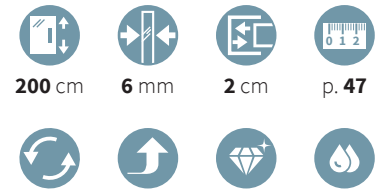

SIDE PANEL FOR YOUNG 2.0 2B

PANEL FIJO LATERAL PARA YOUNG 2.0 2B

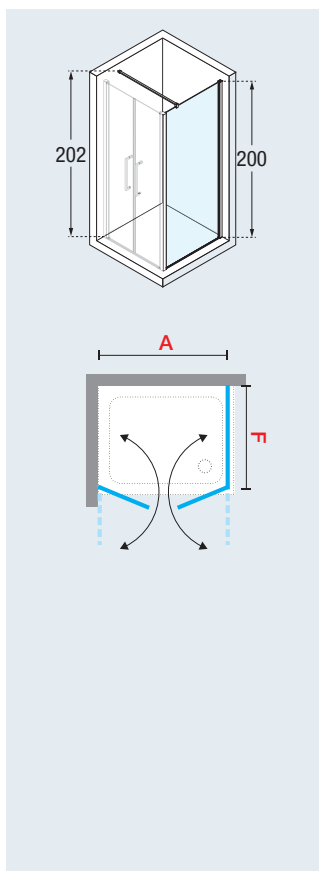

Dimensions Medidas	Code Código	Glass Cristales			Profile type / Price Perfiles / Precio			
		1	2	4	D	B	K	O
Actual dimensions Extensibilidad		Clear Transparente	Aqua	Satin Satinado	White Blanco	Silver	Chrome Cromo	Gold Dorado
F								
57 ↔ 59	Y2 F2B 57-							
59 ↔ 61	Y2 F2B 59-							
65 ↔ 67	Y2 F2B 65-							
67 ↔ 69	Y2 F2B 67-	●						
69 ↔ 71	Y2 F2B 69-							
73 ↔ 75	Y2 F2B 73-							
75 ↔ 77	Y2 F2B 75-							
77 ↔ 79	Y2 F2B 77-	●						
79 ↔ 81	Y2 F2B 79-							
85 ↔ 87	Y2 F2B 85-							
87 ↔ 89	Y2 F2B 87-	●						
89 ↔ 91	Y2 F2B 89-							
95 ↔ 97	Y2 F2B 95-							
97 ↔ 99	Y2 F2B 97-	●						
99 ↔ 101	Y2 F2B 99-							
117 ↔ 119	Y2 F2B 117-							
119 ↔ 121	Y2 F2B 119-							
H 140 ↓ 200 L 20 ↔ 120	SPECIAL Y2 F2B SP							

HOW TO CHOOSE YOUR PRODUCT USING THE CODES:
EJEMPLO DE CÓDIGO:

Y2F2B57-1D

=

Y2F2B57-

+

1

+

D

● In stock - Delivery within 7 business days
Stock disponible - Entrega en un plazo máximo de 7 días



OPTIONAL / OPCIONAL



Support bar
Barra estabilizadora en ángulo

Dimensions <i>Medidas</i>	Code <i>Código</i>	Price / <i>Precio</i>	
		Chrome <i>Cromo</i>	Gold <i>Dorado</i>
15 cm	R80LOU150-	K	O
25 cm	R80LOU250-		
35 cm	R80LOU350-		
45 cm	R80LOU450-		

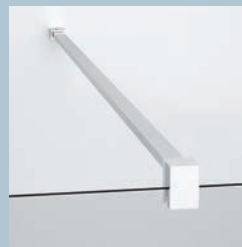

Support bar 150 cm length
Barra de sujeción 150 cm

Profile <i>Color perfil</i>	Code <i>Código</i>	Price <i>Precio</i>
White <i>Blanco</i>	R80Y215-D	
Silver	R80Y215-B	
Chrome <i>Cromo</i>	R80Y215-K	
Gold <i>Dorado</i>	R80Y215-O	



Adjustable bar kit

- 1 adjustable bar of 100 cm (shortened)
- wall attachment
- 1 glass clamp

Kit barra orientable

- Barra de 100 cms
- Pieza sujeción a muro
- Pieza de fijación al cristal

Profile <i>Color perfil</i>	Code <i>Código</i>	Price <i>Precio</i>
White <i>Blanco</i>	R80KUOR100-D	
Silver	R80KUOR100-B	
Chrome <i>Cromo</i>	R80KUOR100-K	



"T" bar kit

support bar of 150 cm to match with the supplied bar for T solution

Kit de barra en "T"

barra de sujeción de 150 cm para instalación en "T"

Profile <i>Color perfil</i>	Code <i>Código</i>	Price <i>Precio</i>
White <i>Blanco</i>	R80Y215T-D	
Silver	R80Y215T-B	
Chrome <i>Cromo</i>	R80Y215T-K	
Gold <i>Dorado</i>	R80Y215T-O	

TECHNICAL DATA / DATOS TÉCNICOS

GLASS TYPES / CRISTAL (EUROPEAN STANDARDS UNI EN 14428)

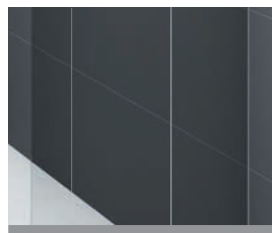

Clear
Transparente
COD. 1



Aqua
COD. 2

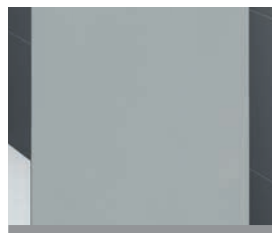

Satin
Satinado
COD. 4

PRINTING / SERIGRAFIA

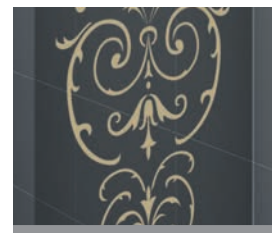

Victoriana Gold
Victoriana Dorado
COD. 72

(only for / solo para 2G, G+F, 1B, R2 LUX)

PROFILE COLOURS / COLORES PERFILES



White
Blanco
COD. D



Silver
COD. B



Chrome
Cromo
COD. K

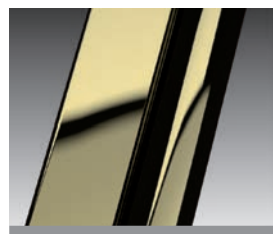

Gold
Dorado
COD. O



(only for / solo para 2G, G+F, 2A, 2B, F2B, G+F in line / en línea, 1B, F1B, A, R, R2, R1 SWIM, R2 LUX)

HANDLES / TIRADOR



Chromed metal handles
Tirador cromo
Interaxis 384mm
Medida entre agujeros de 384 mm

OVERALL DIMENSIONS FIXING PROFILES / MEDIDAS QUE OCUPAN LOS PERFILES EN LA PARED

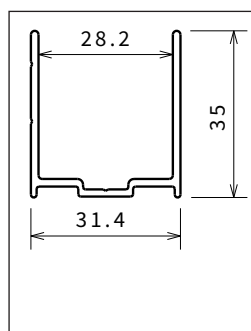

WALL / A PARED

Height Altura	Profile Color perfil	Code Código
1984	White / Blanco	P01BNMOBST-A
1984	Silver	P01BNMOBST-B
1984	Chrome / Cromo	P01BNMOBST-K
1984	Gold / Dorado	P01BNMOBST-O
2000	White / Blanco	P01BNMOAST-A
2000	Silver	P01BNMOAST-B
2000	Chrome / Cromo	P01BNMOAST-K
2000	Gold / Dorado	P01BNMOAST-O

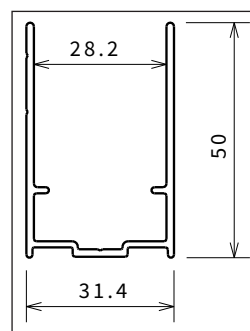

COMPENSATORY / COMPENSADORES

Height Altura	Profile Color perfil	Code Código
1984	White / Blanco	P05Y2ST-A
1984	Silver	P05Y2ST-B
1984	Chrome / Cromo	P05Y2ST-K
1984	Gold / Dorado	P05Y2ST-O
2000	White / Blanco	P05Y2ST2-A
2000	Silver	P05Y2ST2-B
2000	Chrome / Cromo	P05Y2ST2-K
2000	Gold / Dorado	P05Y2ST2-O

HOW TO TAKE THE MEASUREMENT / TOMA DE MEDIDAS

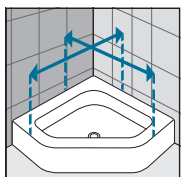
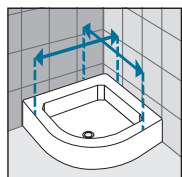
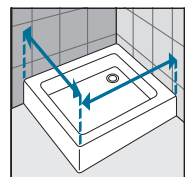

Take the measurements from wall to the external edge of the shower tray. Dimensions must be taken once the walls are finished and tiled, according to the above drawings.

Tomar las medidas desde la pared hasta el borde externo del plato de ducha.

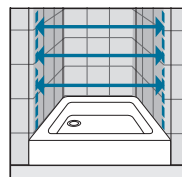

Take the measurements from wall to wall at the bottom, at the top, in the middle and use the smallest. Dimensions must be taken once the walls are finished and tiled, according to the above drawings.

Tomar medidas de pared a pared, medir la parte baja, la central y la superior. Cursar el pedido con la medida más pequeña.

YOUNG 2.0

Less profiles for a clear and essential look. Easy cleaning.

Los perfiles ceden el protagonismo al cristal.

Estética minimalista y comodidad para el día a día.

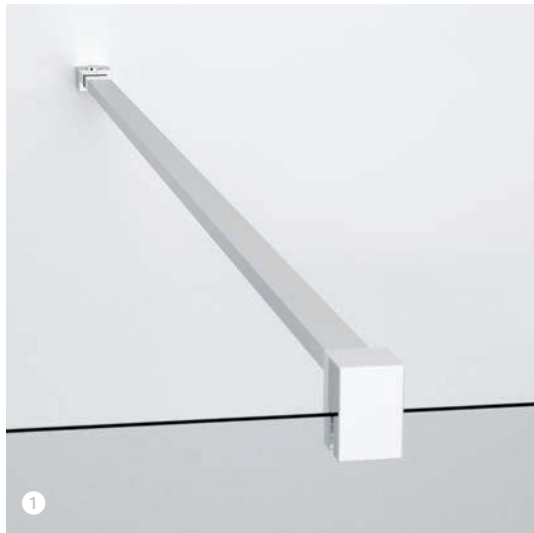

- 1 New support bar / Nueva barra de sujeción a pared
- 2 Chromed metal handle. / Tirador metálico cromo
- 3 Self Rising Hinges / Bisagra con sistema de autoelevación
- 4 In / Out opening of the door. / Sistemas de apertura interior / exterior

TREATMENT / TRATAMIENTOS



CRYSTAL CLEAR TREATMENT

Leaves glass easy to clean. Does not support the growth of bacteria and scale.

Only on transparent glass

TRATAMIENTO ANTIGOTAS

Dificulta la formación de gotas calcáreas. Cristaleses y perfiles siempre brillantes. Fácil de limpiar.

Sólo en cristal transparente.



PVD CHROME AND GOLD FINISH

Zero emission integrated cycle, 100% environment-friendly. Antiscale, antibacteria, ecological, long-time shining resistance.

ACABADO CROMO Y DORADO PVD

Ciclo de producción integrado sin emisiones, 100% ecológico. Anticalcáreo, Antibacterias, Ecológico. Brillo resistente y duradero.

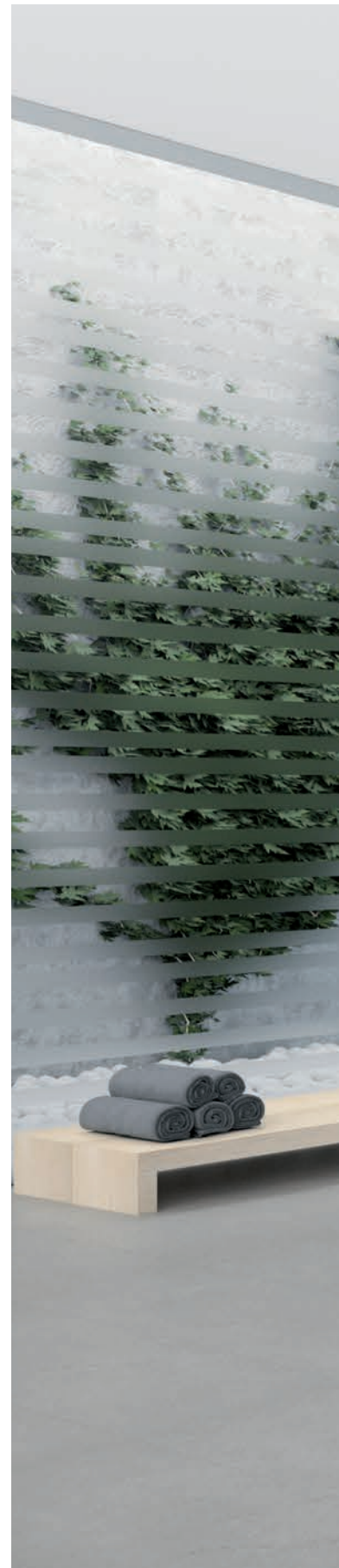

YOUNG 2.0 2G

CORNER ENTRY, 2 HINGED DOORS
ANGULAR DE DOS PUERTAS ABATIBLES

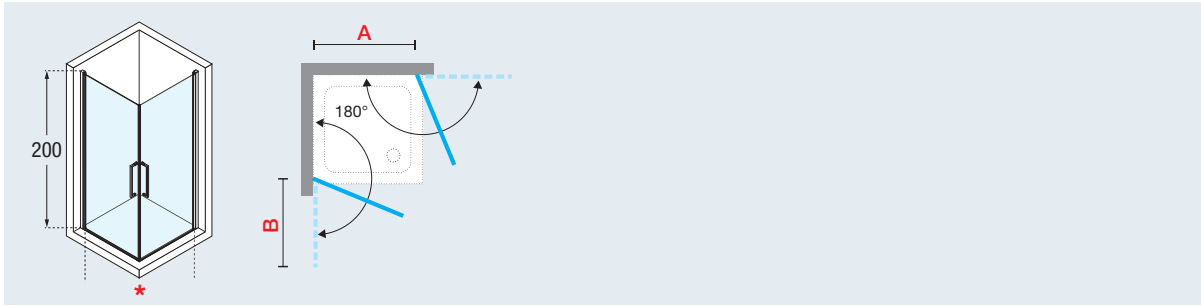

TO COMPLETE A CORNER ENTRY, ORDER 2 SIDES / PARA COMPONER UN ÁNGULO PEDIR 2 LATERALES

Dimensions Medidas			Code Código	Glass Cristales				Profile type / Price Perfiles / Precio			
Actual dimensions Extensibilidad	Access Entrada	Projection Espacio de apertura		1	2	4	72	D	B	K	O
A	*	B		Clear Transparente	Aqua	Satin Satinado	Victoriana Gold / Dorado	White Blanco	Silver	Chrome Cromo	Gold Dorado
57 ↔ 59	69	50	Y2 2G 57 L-								
59 ↔ 61	72	52	Y2 2G 59 L-								
61 ↔ 63	75	54	Y2 2G 61 L-								
65 ↔ 67	81	58	Y2 2G 65 L-								
67 ↔ 69	84	60	Y2 2G 67 L-	●							
69 ↔ 71	87	62	Y2 2G 69 L-								
72 ↔ 74	91	65	Y2 2G 72 L-								
74 ↔ 76	94	67	Y2 2G 74 L-								
77 ↔ 79	98	70	Y2 2G 77 L-	●							
79 ↔ 81	101	72	Y2 2G 79 L-	●							
85 ↔ 87	109	78	Y2 2G 85 L-								
87 ↔ 89	112	80	Y2 2G 87 L-	●							
89 ↔ 91	115	82	Y2 2G 89 L-	●							
95 ↔ 97	124	88	Y2 2G 95 L-	●							
97 ↔ 99	127	90	Y2 2G 97 L-	●							
99 ↔ 101	130	92	Y2 2G 99 L-	●							
H 140 ↓ 200	L 30 ↔ 99	SPECIAL	Y2 2G L SP								

HOW TO CHOOSE YOUR PRODUCT USING THE CODES:
EJEMPLO DE CÓDIGO:

Y22G57L-1D = Y22G57L- + 1 + D

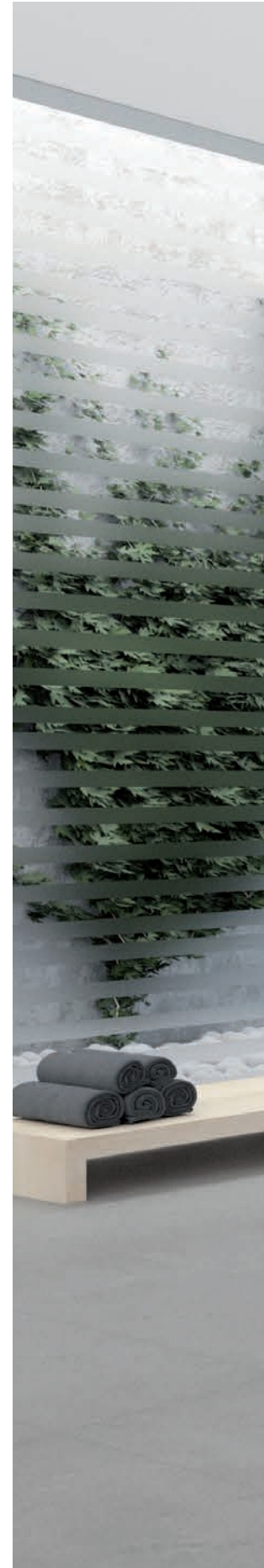

● In stock - Delivery within 7 business days
Stock disponible - Entrega en un plazo máximo de 7 días



200 cm



6 mm



2 cm



p. 47





OPTIONAL / OPCIONAL



Support bar
Barra estabilizadora en ángulo

Dimensions <i>Medidas</i>	Code <i>Código</i>	Price / <i>Precio</i>	
		Chrome <i>Cromo</i>	Gold <i>Dorado</i>
15 cm	R80LOU150-	K	O
25 cm	R80LOU250-		
35 cm	R80LOU350-		
45 cm	R80LOU450-		

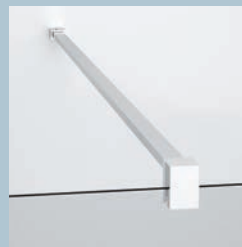

Support bar 150 cm length
Barra de sujeción 150 cm

Profile <i>Color perfil</i>	Code <i>Código</i>	Price <i>Precio</i>
White <i>Blanco</i>	R80Y215-D	
Silver	R80Y215-B	
Chrome <i>Cromo</i>	R80Y215-K	
Gold <i>Dorado</i>	R80Y215-O	



Adjustable bar kit

- 1 adjustable bar of 100 cm (shortened)
- wall attachment
- 1 glass clamp

Kit barra orientable

- Barra de 100 cms
- Pieza sujeción a muro
- Pieza de fijación al cristal

Profile <i>Color perfil</i>	Code <i>Código</i>	Price <i>Precio</i>
White <i>Blanco</i>	R80KUOR100-D	
Silver	R80KUOR100-B	
Chrome <i>Cromo</i>	R80KUOR100-K	



"T" bar kit

support bar of 150 cm to match with the supplied bar for T solution

Kit de barra en "T"

barra de sujeción de 150 cm para instalación en "T"

Profile <i>Color perfil</i>	Code <i>Código</i>	Price <i>Precio</i>
White <i>Blanco</i>	R80Y215T-D	
Silver	R80Y215T-B	
Chrome <i>Cromo</i>	R80Y215T-K	
Gold <i>Dorado</i>	R80Y215T-O	

TECHNICAL DATA / DATOS TÉCNICOS

GLASS TYPES / CRISTAL (EUROPEAN STANDARDS UNI EN 14428)

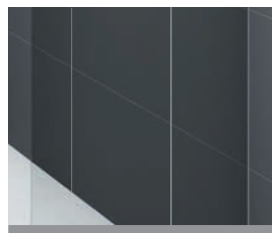

Clear
Transparente
COD. 1



Aqua
COD. 2

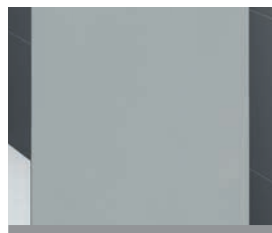

Satin
Satinado
COD. 4

PRINTING / SERIGRAFIA

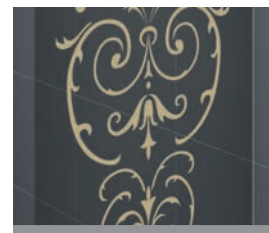

Victoriana Gold
Victoriana Dorado
COD. 72

(only for / solo para 2G, G+F, 1B, R2 LUX)

PROFILE COLOURS / COLORES PERFILES



White
Blanco
COD. D



Silver
COD. B



Chrome
Cromo
COD. K

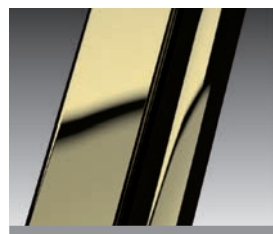

Gold
Dorado
COD. O



(only for / solo para 2G, G+F, 2A, 2B, F2B, G+F in line / en línea, 1B, F1B, A, R, R2, R1 SWIM, R2 LUX)

HANDLES / TIRADOR



Chromed metal handles
Tirador cromo
Interaxis 384mm
Medida entre agujeros de 384 mm

OVERALL DIMENSIONS FIXING PROFILES / MEDIDAS QUE OCUPAN LOS PERFILES EN LA PARED

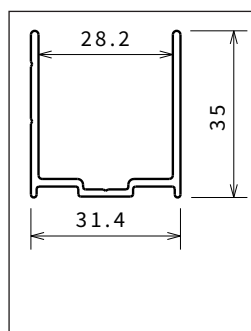

WALL / A PARED

Height Altura	Profile Color perfil	Code Código
1984	White / Blanco	P01BNMOBST-A
1984	Silver	P01BNMOBST-B
1984	Chrome / Cromo	P01BNMOBST-K
1984	Gold / Dorado	P01BNMOBST-O
2000	White / Blanco	P01BNMOAST-A
2000	Silver	P01BNMOAST-B
2000	Chrome / Cromo	P01BNMOAST-K
2000	Gold / Dorado	P01BNMOAST-O

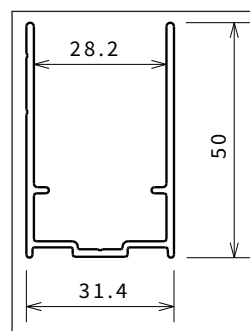

COMPENSATORY / COMPENSADORES

Height Altura	Profile Color perfil	Code Código
1984	White / Blanco	P05Y2ST-A
1984	Silver	P05Y2ST-B
1984	Chrome / Cromo	P05Y2ST-K
1984	Gold / Dorado	P05Y2ST-O
2000	White / Blanco	P05Y2ST2-A
2000	Silver	P05Y2ST2-B
2000	Chrome / Cromo	P05Y2ST2-K
2000	Gold / Dorado	P05Y2ST2-O

HOW TO TAKE THE MEASUREMENT / TOMA DE MEDIDAS

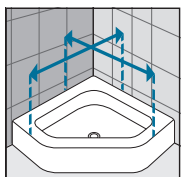
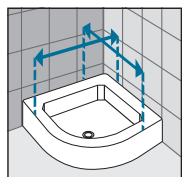
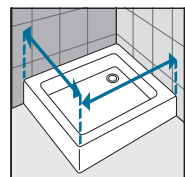

Take the measurements from wall to the external edge of the shower tray. Dimensions must be taken once the walls are finished and tiled, according to the above drawings.

Tomar las medidas desde la pared hasta el borde externo del plato de ducha.

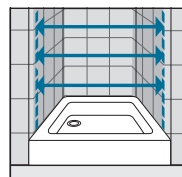

Take the measurements from wall to wall at the bottom, at the top, in the middle and use the smallest. Dimensions must be taken once the walls are finished and tiled, according to the above drawings.

Tomar medidas de pared a pared, medir la parte baja, la central y la superior. Cursar el pedido con la medida más pequeña.

YOUNG 2.0

Less profiles for a clear and essential look. Easy cleaning.

Los perfiles ceden el protagonismo al cristal.

Estética minimalista y comodidad para el día a día.

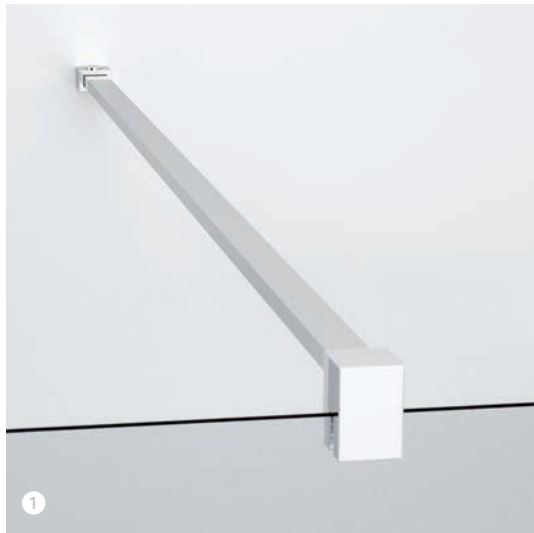

- ① New support bar / Nueva barra de sujeción a pared
- ② Chromed metal handle. / Tirador metálico cromo
- ③ Self Rising Hinges / Bisagra con sistema de autoelevación
- ④ In / Out opening of the door. / Sistemas de apertura interior / exterior

TREATMENT / TRATAMIENTOS



CRYSTAL CLEAR TREATMENT

Leaves glass easy to clean. Does not support the growth of bacteria and scale.

Only on transparent glass

TRATAMIENTO ANTIGOTAS

Dificulta la formación de gotas calcáreas. Cristaleses y perfiles siempre brillantes. Fácil de limpiar.

Sólo en cristal transparente.



PVD CHROME AND GOLD FINISH

Zero emission integrated cycle, 100% environment-friendly. Antiscale, antibacteria, ecological, long-time shining resistance.

ACABADO CROMO Y DORADO PVD

Ciclo de producción integrado sin emisiones, 100% ecológico. Anticalcáreo, Antibacterias, Ecológico. Brillo resistente y duradero.



YOUNG 2.0 2GS

CORNER ENTRY, 2 HINGED FOLDING DOORS
ANGULAR DE DOS PUERTAS PLEGABLES SIN GUIAS

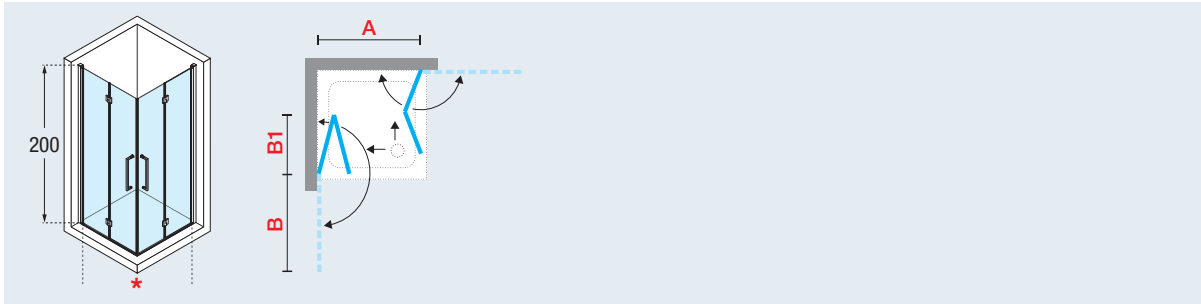

TO COMPLETE A CORNER ENTRY, ORDER 2 SIDES (1 RIGHT SIDE + 1 LEFT SIDE)
PARA COMPONER UN ÁNGULO PEDIR 2 LATERALES

Dimensions Medidas			Code Código	Left Izquierda	Right Derecha	Glass Cristales			Profile type / Price Perfiles / Precio		
Actual dimensions Extensibilidad	Access Entrada	Projection Espacio de apertura		S-	D-	1	2	4	D	B	K
A	*	B	B1			Clear Transparente	Aqua	Satin Satinado	White Blanco	Silver	Chrome Cromo
57 ↔ 59	69	49	23,6	Y2 2GS 57 L							
59 ↔ 61	72	51	24,6	Y2 2GS 59 L							
65 ↔ 67	81	57	27,6	Y2 2GS 65 L							
67 ↔ 69	83	59	28,6	Y2 2GS 67 L							
69 ↔ 71	86	61	29,6	Y2 2GS 69 L							
73 ↔ 75	92	65	31,6	Y2 2GS 73 L							
75 ↔ 77	95	67	32,6	Y2 2GS 75 L							
77 ↔ 79	98	69	33,6	Y2 2GS 77 L							
79 ↔ 81	100	71	34,6	Y2 2GS 79 L							
85 ↔ 87	109	77	37,6	Y2 2GS 85 L							
87 ↔ 89	112	79	38,6	Y2 2GS 87 L							
89 ↔ 91	115	81	39,6	Y2 2GS 89 L							
95 ↔ 97	123	87	42,6	Y2 2GS 95 L							
97 ↔ 99	126	89	43,6	Y2 2GS 97 L							
99 ↔ 101	129	91	44,6	Y2 2GS 99 L							
115 ↔ 117	151	107	52,6	Y2 2GS 115 L							
117 ↔ 119	154	109	53,6	Y2 2GS 117 L							
119 ↔ 121	157	111	54,6	Y2 2GS 119 L							

HOW TO CHOOSE YOUR PRODUCT USING THE CODES:
EJEMPLO DE CÓDIGO:

Y22GS57LS-1D = Y22GS57L + S- + 1 + D

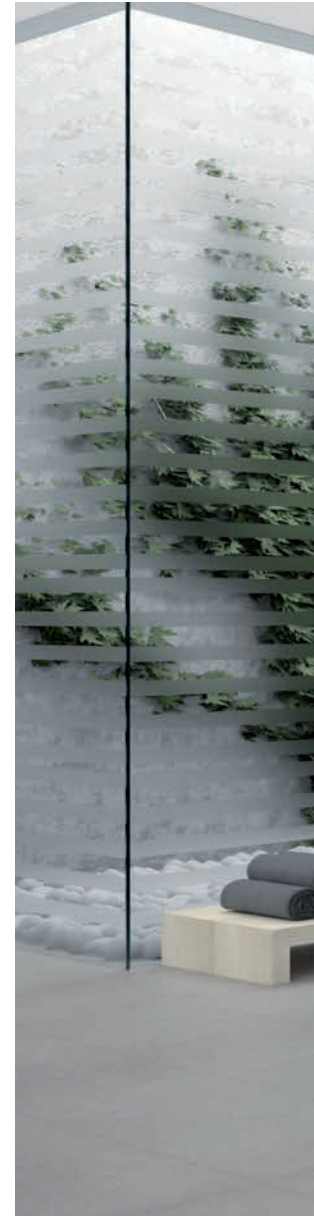

● In stock - Delivery within 7 business days
Stock disponible - Entrega en un plazo máximo de 7 días



200 cm



6 mm



2 cm



p. 47



YOUNG 2.0 2GS+F

CORNER SOLUTION, 1 HINGED FOLDING DOOR + SIDE PANEL
ANGULAR COMPUESTA POR UNA PUERTA PLEGABLE SIN GUÍAS Y UN FIJO LATERAL

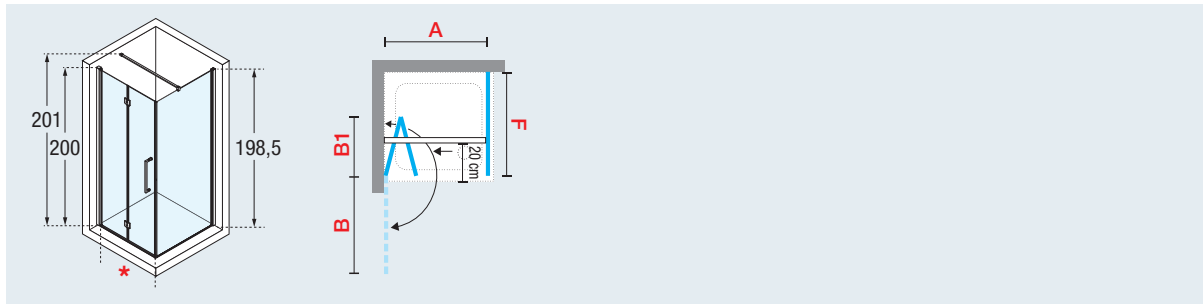

Dimensions / Medidas				Code / Código	Left / Izquierda	Right / Derecha	Glass / Cristales			Profile type / Price / Perfiles / Precio		
Actual dimensions / Extensibilidad	Access / Entrada	Projection / Espacio de apertura			S-	D-	1	2	4	D	B	K
A	*	B	B1				Clear / Transparente	Aqua	Satin / Satinado	White / Blanco	Silver	Chrome / Cromo
58 ↔ 60	49	49	23,6	Y2 2GS 57 L								
60 ↔ 62	51	51	24,6	Y2 2GS 59 L								
66 ↔ 68	57	57	27,6	Y2 2GS 65 L								
68 ↔ 70	59	59	28,6	Y2 2GS 67 L			●					
70 ↔ 72	61	61	29,6	Y2 2GS 69 L			●					
74 ↔ 76	65	65	31,6	Y2 2GS 73 L			●					
76 ↔ 78	67	67	32,6	Y2 2GS 75 L			●					
78 ↔ 80	69	69	33,6	Y2 2GS 77 L			●					
80 ↔ 82	71	71	34,6	Y2 2GS 79 L			●					
86 ↔ 88	77	77	37,6	Y2 2GS 85 L			●					
88 ↔ 90	79	79	38,6	Y2 2GS 87 L			●					
90 ↔ 92	81	81	39,6	Y2 2GS 89 L			●					
96 ↔ 98	87	87	42,6	Y2 2GS 95 L			●					
98 ↔ 100	89	89	43,6	Y2 2GS 97 L			●					
100 ↔ 102	91	91	44,6	Y2 2GS 99 L			●					
116 ↔ 118	107	107	52,6	Y2 2GS 115 L			●					
118 ↔ 120	109	109	53,6	Y2 2GS 117 L			●					
120 ↔ 122	111	111	54,6	Y2 2GS 119 L			●					

SIDE PANEL / FIJO PANEL

F												
57 ↔ 59	-	-	-	Y2 FG 57-								
59 ↔ 61	-	-	-	Y2 FG 59-								
61 ↔ 63	-	-	-	Y2 FG 61-								
65 ↔ 67	-	-	-	Y2 FG 65-								
67 ↔ 69	-	-	-	Y2 FG 67-			●					
69 ↔ 71	-	-	-	Y2 FG 69-			●					
73 ↔ 75	-	-	-	Y2 FG 73-			●					
75 ↔ 77	-	-	-	Y2 FG 75-			●					
77 ↔ 79	-	-	-	Y2 FG 77-			●					
79 ↔ 81	-	-	-	Y2 FG 79-			●					
85 ↔ 87	-	-	-	Y2 FG 85-			●					
87 ↔ 89	-	-	-	Y2 FG 87-			●					
89 ↔ 91	-	-	-	Y2 FG 89-			●					
95 ↔ 97	-	-	-	Y2 FG 95-			●					
97 ↔ 99	-	-	-	Y2 FG 97-			●					
99 ↔ 101	-	-	-	Y2 FG 99-			●					
117 ↔ 119	-	-	-	Y2 FG 117-			●					
119 ↔ 121	-	-	-	Y2 FG 119-			●					

* H 140 ↓ 200 L 20 ↔ 120 SPECIAL Y2 FG SP

HOW TO CHOOSE YOUR PRODUCT USING THE CODES:
EJEMPLO DE CÓDIGO:

Y22GS57LS-1D

= Y22GS57L

+ S-

+ 1

+ D

- * Special side panel must be ordered the same height of the door
- * El fijo especial debe ser de la misma altura que la puerta

● In stock - Delivery within 7 business days
Stock disponible - Entrega en un plazo máximo de 7 días





200 cm



6 mm



2 cm



Door
Puerta



Side panel
Fijo panel



p. 47





OPTIONAL / OPCIONAL



Support bar
Barra estabilizadora en ángulo

Dimensions <i>Medidas</i>	Code <i>Código</i>	Price / <i>Precio</i>	
		Chrome <i>Cromo</i>	Gold <i>Dorado</i>
15 cm	R80LOU150-	K	O
25 cm	R80LOU250-		
35 cm	R80LOU350-		
45 cm	R80LOU450-		

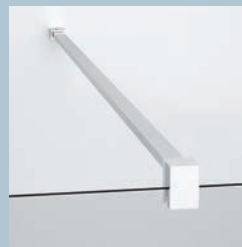

Support bar 150 cm length
Barra de sujeción 150 cm

Profile <i>Color perfil</i>	Code <i>Código</i>	Price <i>Precio</i>
White <i>Blanco</i>	R80Y215-D	
Silver	R80Y215-B	
Chrome <i>Cromo</i>	R80Y215-K	
Gold <i>Dorado</i>	R80Y215-O	



Adjustable bar kit

- 1 adjustable bar of 100 cm (shortened)
- wall attachment
- 1 glass clamp

Kit barra orientable

- Barra de 100 cms
- Pieza sujeción a muro
- Pieza de fijación al cristal

Profile <i>Color perfil</i>	Code <i>Código</i>	Price <i>Precio</i>
White <i>Blanco</i>	R80KUOR100-D	
Silver	R80KUOR100-B	
Chrome <i>Cromo</i>	R80KUOR100-K	



"T" bar kit

support bar of 150 cm to match with the supplied bar for T solution

Kit de barra en "T"

barra de sujeción de 150 cm para instalación en "T"

Profile <i>Color perfil</i>	Code <i>Código</i>	Price <i>Precio</i>
White <i>Blanco</i>	R80Y215T-D	
Silver	R80Y215T-B	
Chrome <i>Cromo</i>	R80Y215T-K	
Gold <i>Dorado</i>	R80Y215T-O	

TECHNICAL DATA / DATOS TÉCNICOS

GLASS TYPES / CRISTAL (EUROPEAN STANDARDS UNI EN 14428)

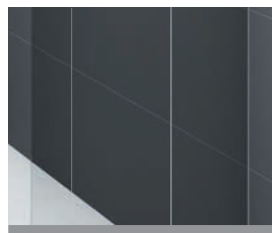

Clear
Transparente
COD. 1



Aqua
COD. 2

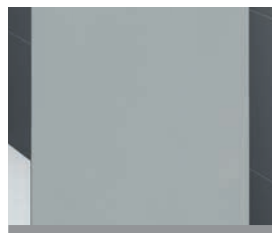

Satin
Satinado
COD. 4

PRINTING / SERIGRAFIA

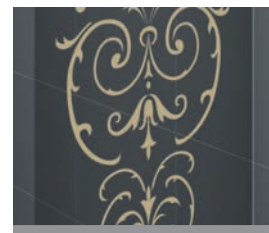

Victoriana Gold
Victoriana Dorado
COD. 72

(only for / solo para 2G, G+F, 1B, R2 LUX)

PROFILE COLOURS / COLORES PERFILES



White
Blanco
COD. D



Silver
COD. B



Chrome
Cromo
COD. K

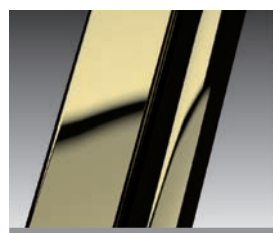

Gold
Dorado
COD. O



(only for / solo para 2G, G+F, 2A, 2B, F2B, G+F in line / en línea, 1B, F1B, A, R, R2, R1 SWIM, R2 LUX)

HANDLES / TIRADOR



Chromed metal handles
Tirador cromo
Interaxis 384mm
Medida entre agujeros de 384 mm

OVERALL DIMENSIONS FIXING PROFILES / MEDIDAS QUE OCUPAN LOS PERFILES EN LA PARED

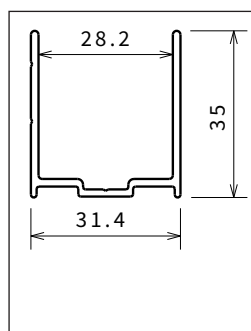

WALL / A PARED

Height Altura	Profile Color perfil	Code Código
1984	White / Blanco	P01BNMOBST-A
1984	Silver	P01BNMOBST-B
1984	Chrome / Cromo	P01BNMOBST-K
1984	Gold / Dorado	P01BNMOBST-O
2000	White / Blanco	P01BNMOAST-A
2000	Silver	P01BNMOAST-B
2000	Chrome / Cromo	P01BNMOAST-K
2000	Gold / Dorado	P01BNMOAST-O

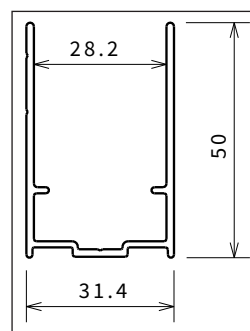

COMPENSATORY / COMPENSADORES

Height Altura	Profile Color perfil	Code Código
1984	White / Blanco	P05Y2ST-A
1984	Silver	P05Y2ST-B
1984	Chrome / Cromo	P05Y2ST-K
1984	Gold / Dorado	P05Y2ST-O
2000	White / Blanco	P05Y2ST2-A
2000	Silver	P05Y2ST2-B
2000	Chrome / Cromo	P05Y2ST2-K
2000	Gold / Dorado	P05Y2ST2-O

HOW TO TAKE THE MEASUREMENT / TOMA DE MEDIDAS

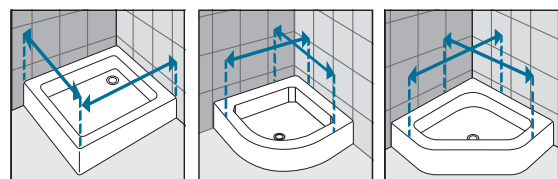

Take the measurements from wall to the external edge of the shower tray. Dimensions must be taken once the walls are finished and tiled, according to the above drawings.

Tomar las medidas desde la pared hasta el borde externo del plato de ducha.

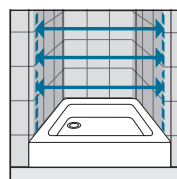

Take the measurements from wall to wall at the bottom, at the top, in the middle and use the smallest. Dimensions must be taken once the walls are finished and tiled, according to the above drawings.

Tomar medidas de pared a pared, medir la parte baja, la superior y la central. Cursar el pedido con la medida más pequeña.

YOUNG 2.0

Less profiles for a clear and essential look. Easy cleaning.

Los perfiles ceden el protagonismo al cristal.

Estética minimalista y comodidad para el día a día.

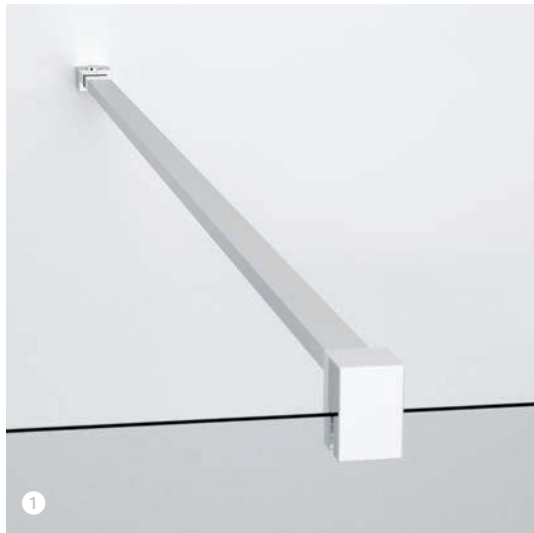

- 1 New support bar / Nueva barra de sujeción a pared
- 2 Chromed metal handle. / Tirador metálico cromo
- 3 Self Rising Hinges / Bisagra con sistema de autoelevación
- 4 In / Out opening of the door. / Sistemas de apertura interior / exterior

TREATMENT / TRATAMIENTOS



CRYSTAL CLEAR TREATMENT

Leaves glass easy to clean. Does not support the growth of bacteria and scale.

Only on transparent glass

TRATAMIENTO ANTIGOTAS

Dificulta la formación de gotas calcáreas. Cristaleses y perfiles siempre brillantes. Fácil de limpiar.

Sólo en cristal transparente.



PVD CHROME AND GOLD FINISH

Zero emission integrated cycle, 100% environment-friendly.

Antiscale, antibacteria, ecological, long-time shining resistance.

ACABADO CROMO Y DORADO PVD

Ciclo de producción integrado sin emisiones, 100% ecológico.

Anticalcáreo, Antibacterias, Ecológico. Brillo resistente y duradero.

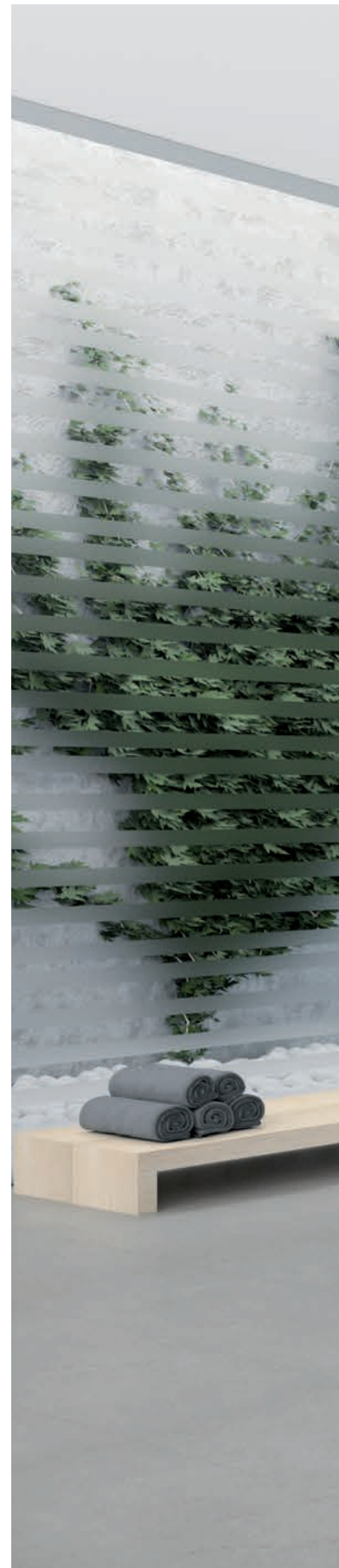

YOUNG 2.0 2GS

CORNER ENTRY, 2 HINGED FOLDING DOORS
ANGULAR DE DOS PUERTAS PLEGABLES SIN GUIAS

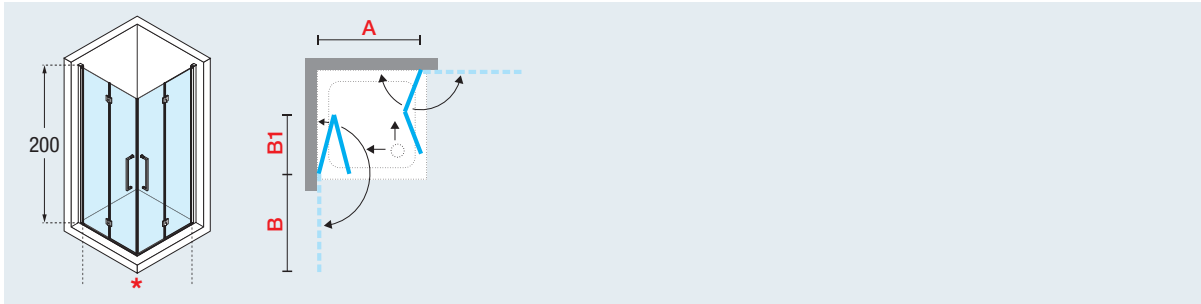

TO COMPLETE A CORNER ENTRY, ORDER 2 SIDES (1 RIGHT SIDE + 1 LEFT SIDE)
PARA COMPONER UN ÁNGULO PEDIR 2 LATERALES

Dimensions Medidas				Code Código	Left Izquierda	Right Derecha	Glass Cristales			Profile type / Price Perfiles / Precio			
Actual dimensions Extensibilidad	Access Entrada	Projection Espacio de apertura			S-	D-	1	2	4	D	B	K	
A	*	B	B1				Clear Transparente	Aqua	Satin Satinado	White Blanco	Silver	Chrome Cromo	
57 ↔ 59	69	49	23,6	Y2 2GS 57 L									
59 ↔ 61	72	51	24,6	Y2 2GS 59 L									
65 ↔ 67	81	57	27,6	Y2 2GS 65 L									
67 ↔ 69	83	59	28,6	Y2 2GS 67 L									
69 ↔ 71	86	61	29,6	Y2 2GS 69 L									
73 ↔ 75	92	65	31,6	Y2 2GS 73 L									
75 ↔ 77	95	67	32,6	Y2 2GS 75 L									
77 ↔ 79	98	69	33,6	Y2 2GS 77 L									
79 ↔ 81	100	71	34,6	Y2 2GS 79 L									
85 ↔ 87	109	77	37,6	Y2 2GS 85 L									
87 ↔ 89	112	79	38,6	Y2 2GS 87 L									
89 ↔ 91	115	81	39,6	Y2 2GS 89 L									
95 ↔ 97	123	87	42,6	Y2 2GS 95 L									
97 ↔ 99	126	89	43,6	Y2 2GS 97 L									
99 ↔ 101	129	91	44,6	Y2 2GS 99 L									
115 ↔ 117	151	107	52,6	Y2 2GS 115 L									
117 ↔ 119	154	109	53,6	Y2 2GS 117 L									
119 ↔ 121	157	111	54,6	Y2 2GS 119 L									

HOW TO CHOOSE YOUR PRODUCT USING THE CODES:
EJEMPLO DE CÓDIGO:

Y22GS57LS-1D = Y22GS57L + S- + 1 + D

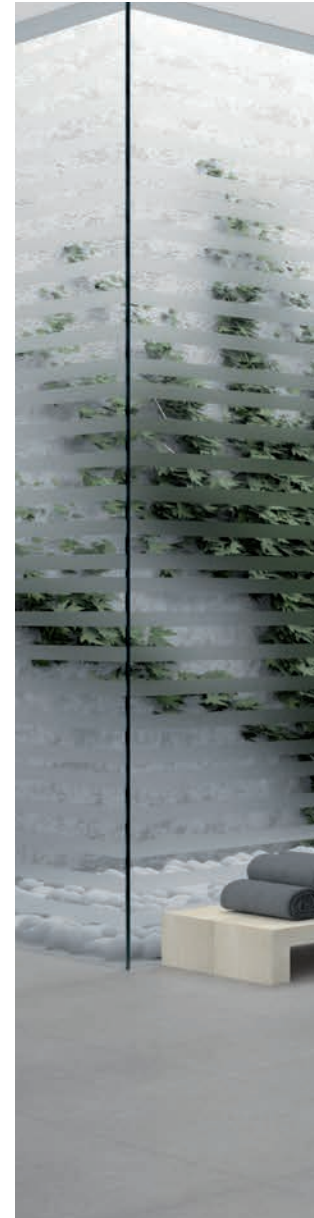

● In stock - Delivery within 7 business days
Stock disponible - Entrega en un plazo máximo de 7 días



200 cm



6 mm



2 cm



p. 47



YOUNG 2.0 2GS+F

CORNER SOLUTION, 1 HINGED FOLDING DOOR + SIDE PANEL
ANGULAR COMPUESTA POR UNA PUERTA PLEGABLE SIN GUÍAS Y UN FIJO LATERAL

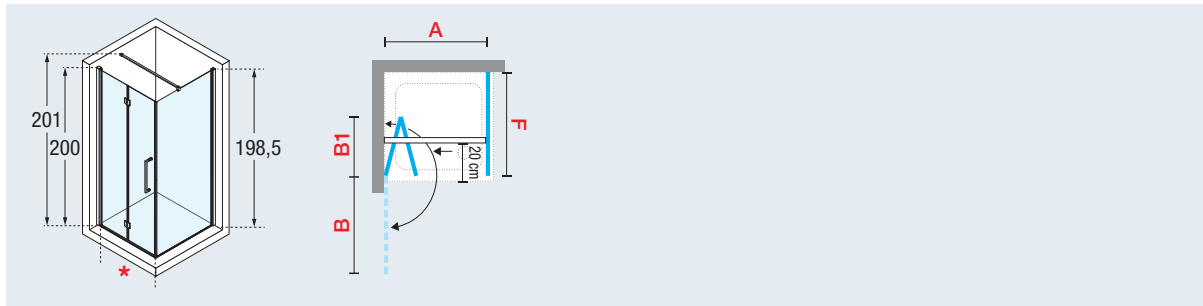

Dimensions / Medidas				Code / Código	Left / Izquierda	Right / Derecha	Glass / Cristales			Profile type / Price / Perfiles / Precio		
Actual dimensions / Extensibilidad	Access / Entrada	Projection / Espacio de apertura			S-	D-	1	2	4	D	B	K
A	*	B	B1				Clear / Transparente	Aqua	Satin / Satinado	White / Blanco	Silver	Chrome / Cromo
58 ↔ 60	49	49	23,6	Y2 2GS 57 L								
60 ↔ 62	51	51	24,6	Y2 2GS 59 L								
66 ↔ 68	57	57	27,6	Y2 2GS 65 L								
68 ↔ 70	59	59	28,6	Y2 2GS 67 L			●					
70 ↔ 72	61	61	29,6	Y2 2GS 69 L			●					
74 ↔ 76	65	65	31,6	Y2 2GS 73 L			●					
76 ↔ 78	67	67	32,6	Y2 2GS 75 L			●					
78 ↔ 80	69	69	33,6	Y2 2GS 77 L			●					
80 ↔ 82	71	71	34,6	Y2 2GS 79 L			●					
86 ↔ 88	77	77	37,6	Y2 2GS 85 L			●					
88 ↔ 90	79	79	38,6	Y2 2GS 87 L			●					
90 ↔ 92	81	81	39,6	Y2 2GS 89 L			●					
96 ↔ 98	87	87	42,6	Y2 2GS 95 L			●					
98 ↔ 100	89	89	43,6	Y2 2GS 97 L			●					
100 ↔ 102	91	91	44,6	Y2 2GS 99 L			●					
116 ↔ 118	107	107	52,6	Y2 2GS 115 L			●					
118 ↔ 120	109	109	53,6	Y2 2GS 117 L			●					
120 ↔ 122	111	111	54,6	Y2 2GS 119 L			●					

SIDE PANEL / FIJO PANEL

F												
57 ↔ 59	-	-	-	Y2 FG 57-								
59 ↔ 61	-	-	-	Y2 FG 59-								
61 ↔ 63	-	-	-	Y2 FG 61-								
65 ↔ 67	-	-	-	Y2 FG 65-								
67 ↔ 69	-	-	-	Y2 FG 67-			●					
69 ↔ 71	-	-	-	Y2 FG 69-			●					
73 ↔ 75	-	-	-	Y2 FG 73-			●					
75 ↔ 77	-	-	-	Y2 FG 75-			●					
77 ↔ 79	-	-	-	Y2 FG 77-			●					
79 ↔ 81	-	-	-	Y2 FG 79-			●					
85 ↔ 87	-	-	-	Y2 FG 85-			●					
87 ↔ 89	-	-	-	Y2 FG 87-			●					
89 ↔ 91	-	-	-	Y2 FG 89-			●					
95 ↔ 97	-	-	-	Y2 FG 95-			●					
97 ↔ 99	-	-	-	Y2 FG 97-			●					
99 ↔ 101	-	-	-	Y2 FG 99-			●					
117 ↔ 119	-	-	-	Y2 FG 117-			●					
119 ↔ 121	-	-	-	Y2 FG 119-			●					

* H 140 ↓ 200 L 20 ↔ 120 SPECIAL Y2 FG SP

HOW TO CHOOSE YOUR PRODUCT USING THE CODES:
EJEMPLO DE CÓDIGO:

Y22GS57LS-1D = Y22GS57L + S- + 1 + D

- * Special side panel must be ordered the same height of the door
- * El fijo especial debe ser de la misma altura que la puerta

● In stock - Delivery within 7 business days
Stock disponible - Entrega en un plazo máximo de 7 días





200 cm



6 mm



2 cm



Door
Puerta



Side panel
Fijo panel



p. 47





OPTIONAL / OPCIONAL



Support bar
Barra estabilizadora en ángulo

Dimensions <i>Medidas</i>	Code <i>Código</i>	Price / <i>Precio</i>	
		Chrome <i>Cromo</i>	Gold <i>Dorado</i>
15 cm	R80LOU150-	K	O
25 cm	R80LOU250-		
35 cm	R80LOU350-		
45 cm	R80LOU450-		

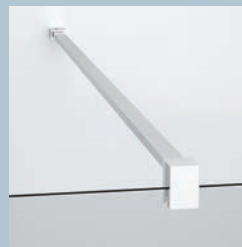

Support bar 150 cm length
Barra de sujeción 150 cm

Profile <i>Color perfil</i>	Code <i>Código</i>	Price <i>Precio</i>
White <i>Blanco</i>	R80Y215-D	
Silver	R80Y215-B	
Chrome <i>Cromo</i>	R80Y215-K	
Gold <i>Dorado</i>	R80Y215-O	



Adjustable bar kit

- 1 adjustable bar of 100 cm (shortened)
- wall attachment
- 1 glass clamp

Kit barra orientable

- Barra de 100 cms
- Pieza sujeción a muro
- Pieza de fijación al cristal

Profile <i>Color perfil</i>	Code <i>Código</i>	Price <i>Precio</i>
White <i>Blanco</i>	R80KUOR100-D	
Silver	R80KUOR100-B	
Chrome <i>Cromo</i>	R80KUOR100-K	



"T" bar kit

support bar of 150 cm to match with the supplied bar for T solution

Kit de barra en "T"

barra de sujeción de 150 cm para instalación en "T"

Profile <i>Color perfil</i>	Code <i>Código</i>	Price <i>Precio</i>
White <i>Blanco</i>	R80Y215T-D	
Silver	R80Y215T-B	
Chrome <i>Cromo</i>	R80Y215T-K	
Gold <i>Dorado</i>	R80Y215T-O	

TECHNICAL DATA / DATOS TÉCNICOS

GLASS TYPES / CRISTAL (EUROPEAN STANDARDS UNI EN 14428)

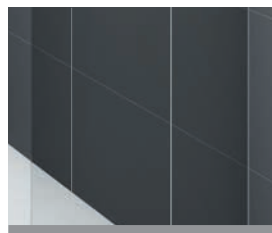

Clear
Transparente
COD. 1



Aqua
COD. 2

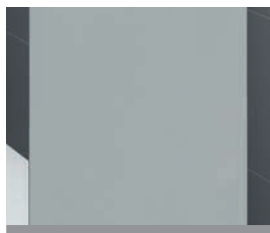

Satin
Satinado
COD. 4

PRINTING / SERIGRAFIA

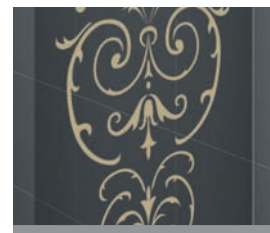

Victoriana Gold
Victoriana Dorado
COD. 72

(only for / solo para 2G, G+F, 1B, R2 LUX)

PROFILE COLOURS / COLORES PERFILES



White
Blanco
COD. D



Silver
COD. B



Chrome
Cromo
COD. K

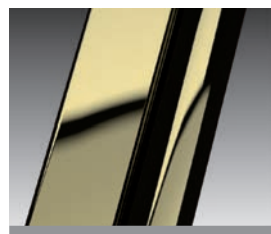

Gold
Dorado
COD. O



(only for / solo para 2G, G+F, 2A, 2B, F2B, G+F in line / en línea, 1B, F1B, A, R, R2, R1 SWIM, R2 LUX)

HANDLES / TIRADOR



Chromed metal handles
Tirador cromo
Interaxis 384mm
Medida entre agujeros de 384 mm

OVERALL DIMENSIONS FIXING PROFILES / MEDIDAS QUE OCUPAN LOS PERFILES EN LA PARED

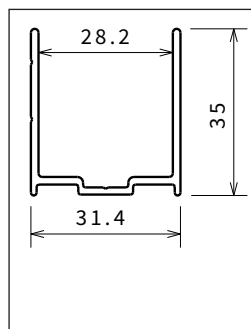

WALL / A PARED

Height Altura	Profile Color perfil	Code Código
1984	White / Blanco	P01BNMOBST-A
1984	Silver	P01BNMOBST-B
1984	Chrome / Cromo	P01BNMOBST-K
1984	Gold / Dorado	P01BNMOBST-O
2000	White / Blanco	P01BNMOAST-A
2000	Silver	P01BNMOAST-B
2000	Chrome / Cromo	P01BNMOAST-K
2000	Gold / Dorado	P01BNMOAST-O

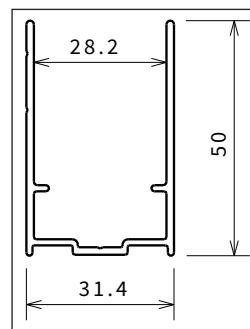

COMPENSATORY / COMPENSADORES

Height Altura	Profile Color perfil	Code Código
1984	White / Blanco	P05Y2ST-A
1984	Silver	P05Y2ST-B
1984	Chrome / Cromo	P05Y2ST-K
1984	Gold / Dorado	P05Y2ST-O
2000	White / Blanco	P05Y2ST2-A
2000	Silver	P05Y2ST2-B
2000	Chrome / Cromo	P05Y2ST2-K
2000	Gold / Dorado	P05Y2ST2-O

HOW TO TAKE THE MEASUREMENT / TOMA DE MEDIDAS

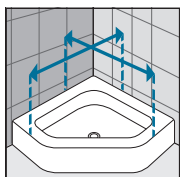
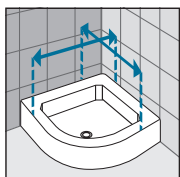
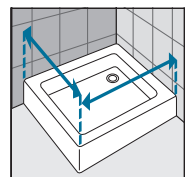

Take the measurements from wall to the external edge of the shower tray. Dimensions must be taken once the walls are finished and tiled, according to the above drawings.

Tomar las medidas desde la pared hasta el borde externo del plato de ducha.

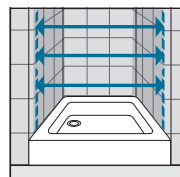

Take the measurements from wall to wall at the bottom, at the top, in the middle and use the smallest. Dimensions must be taken once the walls are finished and tiled, according to the above drawings.

Tomar medidas de pared a pared, medir la parte baja, la central y la superior. Cursar el pedido con la medida más pequeña.

YOUNG 2.0

Less profiles for a clear and essential look. Easy cleaning.

Los perfiles ceden el protagonismo al cristal.

Estética minimalista y comodidad para el día a día.

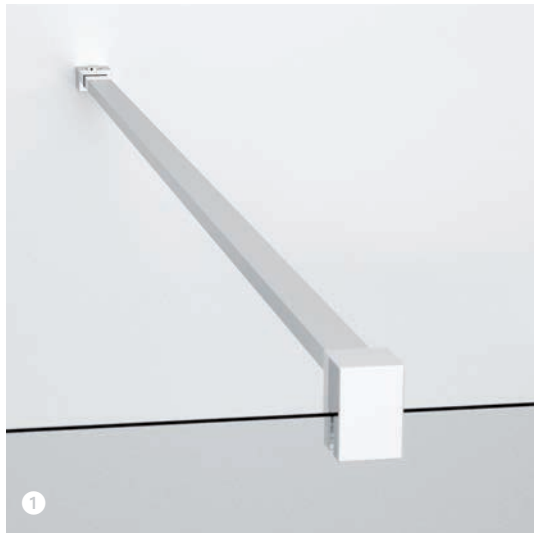

- ① New support bar / Nueva barra de sujeción a pared
- ② Chromed metal handle. / Tirador metálico cromo
- ③ Self Rising Hinges / Bisagra con sistema de autoelevación
- ④ In / Out opening of the door. / Sistemas de apertura interior / exterior

TREATMENT / TRATAMIENTOS



CRYSTAL CLEAR TREATMENT

Leaves glass easy to clean. Does not support the growth of bacteria and scale.

Only on transparent glass

TRATAMIENTO ANTIGOTAS

Dificulta la formación de gotas calcáreas. Cristaleses y perfiles siempre brillantes. Fácil de limpiar.

Sólo en cristal transparente.



PVD CHROME AND GOLD FINISH

Zero emission integrated cycle, 100% environment-friendly. Antiscale, antibacteria, ecological, long-time shining resistance.

ACABADO CROMO Y DORADO PVD

Ciclo de producción integrado sin emisiones, 100% ecológico. Anticalcáreo, Antibacterias, Ecológico. Brillo resistente y duradero.

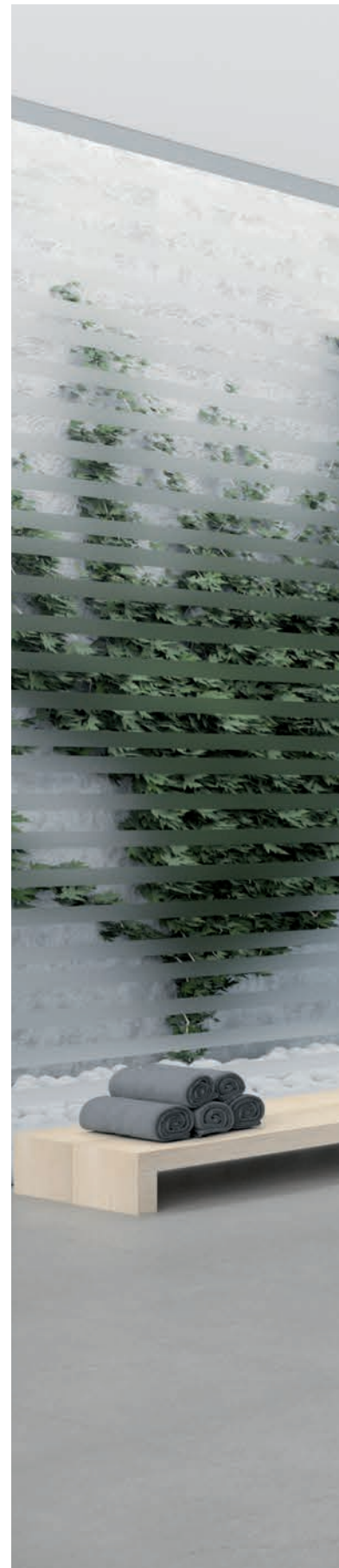

YOUNG 2.0 **G+F** IN LINE / EN LÍNEA

SHOWER DOOR, 1 HINGED DOOR + 1 FIXED PANEL IN LINE
MAMPARA DE UNA PUERTA ABATIBLE + FIJO EN LÍNEA

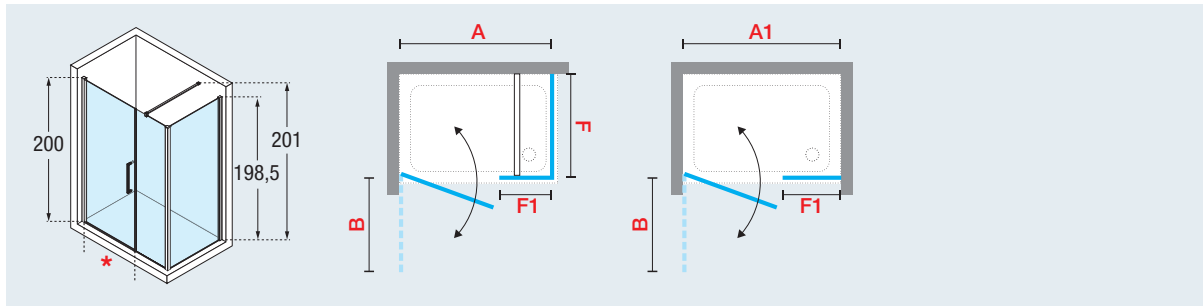

Dimensions Medidas					Code Código	Glass Cristales			Profile type / Price Perfiles / Precio			
Actual dimensions Extensibilidad	Fix panel in line Fijo panel en línea	Access Entrada	Projection Espacio de apertura			1	2	4	D	B	K	O
With side panel Con fijo panel	For recess Entre paredes											

DOOR / PUERTA

A	A1	F1	*	B	
98 ↔ 102	97 ↔ 101	32,5	58	59	Y2 GFL 97-
115 ↔ 119	114 ↔ 118	39,5	68	69	Y2 GFL 114-
118 ↔ 122	117 ↔ 121	42,5	68	69	Y2 GFL 117-
138 ↔ 142	137 ↔ 141	52,5	78	79	Y2 GFL 137-
148 ↔ 152	147 ↔ 151	52,5	88	89	Y2 GFL 147-
158 ↔ 162	157 ↔ 161	62,5	88	89	Y2 GFL 157-
168 ↔ 172	167 ↔ 171	72,5	88	89	Y2 GFL 167-
178 ↔ 182	177 ↔ 181	82,5	88	89	Y2 GFL 177-

H 140 ↓ 200 L 97 ↔ 177

SPECIAL **Y2 GFL SP**

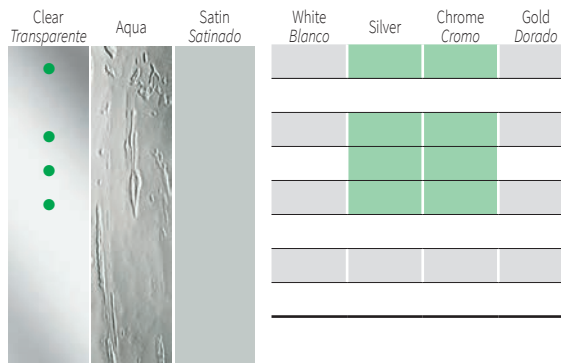

SIDE PANEL / FIJO PANEL

F					
57 ↔ 59	-	-	-	-	Y2 F1B 57-
59 ↔ 61	-	-	-	-	Y2 F1B 59-
65 ↔ 67	-	-	-	-	Y2 F1B 65-
67 ↔ 69	-	-	-	-	Y2 F1B 67-
69 ↔ 71	-	-	-	-	Y2 F1B 69-
73 ↔ 75	-	-	-	-	Y2 F1B 73-
75 ↔ 77	-	-	-	-	Y2 F1B 75-
77 ↔ 79	-	-	-	-	Y2 F1B 77-
79 ↔ 81	-	-	-	-	Y2 F1B 79-
85 ↔ 87	-	-	-	-	Y2 F1B 85-
87 ↔ 89	-	-	-	-	Y2 F1B 87-
89 ↔ 91	-	-	-	-	Y2 F1B 89-
95 ↔ 97	-	-	-	-	Y2 F1B 95-
97 ↔ 99	-	-	-	-	Y2 F1B 97-
99 ↔ 101	-	-	-	-	Y2 F1B 99-
117 ↔ 119	-	-	-	-	Y2 F1B 117-
119 ↔ 121	-	-	-	-	Y2 F1B 119-

* H 140 ↓ 200 L 20 ↔ 120

SPECIAL **Y2 F1B SP**

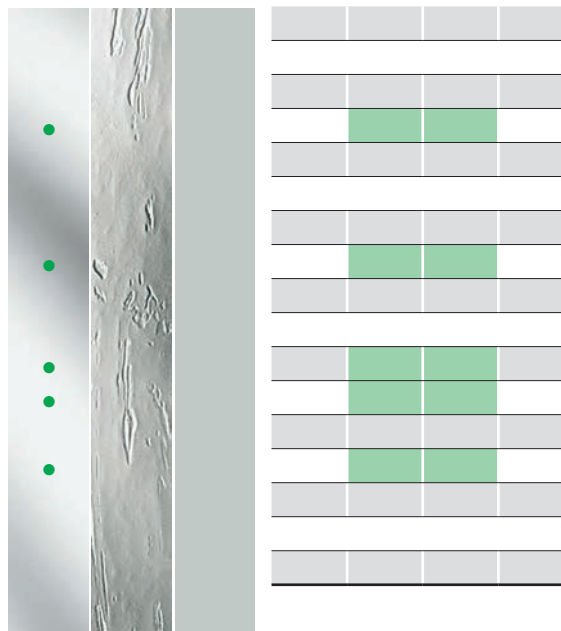

HOW TO CHOOSE YOUR PRODUCT USING THE CODES:
 EJEMPLO DE CÓDIGO:

Y2GFL97-1D = Y2GFL97- + 1 + D

Standar support bar supplied cm 100
OPTIONAL support bar of cm 150.

Barra de sujeción 100 cm. incluida.
OPCIONAL: barra de sujeción 150 cm.

* Special side panel must be ordered the same height of the door
 * El fijo especial debe ser de la misma altura que la puerta

● In stock - Delivery within 7 business days
 Stock disponible - Entrega en un plazo máximo de 7 días





200 cm



6 mm



Door
Puerta
4 cm



Side panel
Fijo panel
2 cm



p. 47



IN / OUT OPENING OF THE DOOR
APERTURA INTERIOR - EXTERIOR



OPTIONAL / OPCIONAL



Support bar
Barra estabilizadora en ángulo

Dimensions <i>Medidas</i>	Code <i>Código</i>	Price / Precio	
		Chrome <i>Cromo</i>	Gold <i>Dorado</i>
15 cm	R80LOU150-	K	O
25 cm	R80LOU250-		
35 cm	R80LOU350-		
45 cm	R80LOU450-		

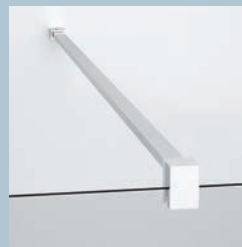

Support bar 150 cm length
Barra de sujeción 150 cm

Profile <i>Color perfil</i>	Code <i>Código</i>	Price <i>Precio</i>
White <i>Blanco</i>	R80Y215-D	
Silver	R80Y215-B	
Chrome <i>Cromo</i>	R80Y215-K	
Gold <i>Dorado</i>	R80Y215-O	



Adjustable bar kit

- 1 adjustable bar of 100 cm (shortened)
- wall attachment
- 1 glass clamp

Kit barra orientable

- Barra de 100 cms
- Pieza sujeción a muro
- Pieza de fijación al cristal

Profile <i>Color perfil</i>	Code <i>Código</i>	Price <i>Precio</i>
White <i>Blanco</i>	R80KUOR100-D	
Silver	R80KUOR100-B	
Chrome <i>Cromo</i>	R80KUOR100-K	



"T" bar kit

support bar of 150 cm to match with the supplied bar for T solution

Kit de barra en "T"

barra de sujeción de 150 cm para instalación en "T"

Profile <i>Color perfil</i>	Code <i>Código</i>	Price <i>Precio</i>
White <i>Blanco</i>	R80Y215T-D	
Silver	R80Y215T-B	
Chrome <i>Cromo</i>	R80Y215T-K	
Gold <i>Dorado</i>	R80Y215T-O	

TECHNICAL DATA / DATOS TÉCNICOS

GLASS TYPES / CRISTAL (EUROPEAN STANDARDS UNI EN 14428)

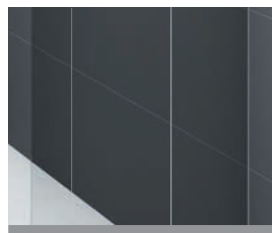

Clear
Transparente
COD. 1



Aqua
COD. 2

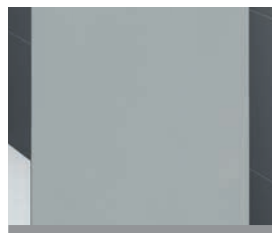

Satin
Satinado
COD. 4

PRINTING / SERIGRAFIA

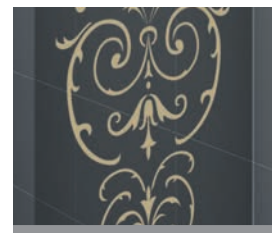

Victoriana Gold
Victoriana Dorado
COD. 72

(only for / solo para 2G, G+F, 1B, R2 LUX)

PROFILE COLOURS / COLORES PERFILES



White
Blanco
COD. D



Silver
COD. B



Chrome
Cromo
COD. K

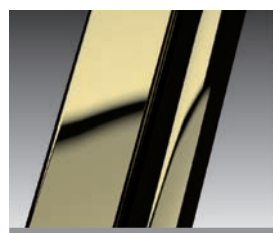

Gold
Dorado
COD. O



(only for / solo para 2G, G+F, 2A, 2B, F2B, G+F in line / en línea, 1B, F1B, A, R, R2, R1 SWIM, R2 LUX)

HANDLES / TIRADOR



Chromed metal handles
Tirador cromo
Interaxis 384mm
Medida entre agujeros de 384 mm

OVERALL DIMENSIONS FIXING PROFILES / MEDIDAS QUE OCUPAN LOS PERFILES EN LA PARED

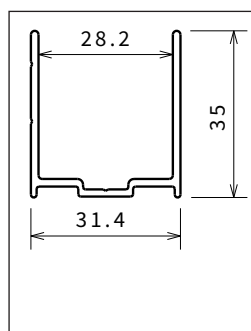

WALL / A PARED

Height Altura	Profile Color perfil	Code Código
1984	White / Blanco	P01BNMOBST-A
1984	Silver	P01BNMOBST-B
1984	Chrome / Cromo	P01BNMOBST-K
1984	Gold / Dorado	P01BNMOBST-O
2000	White / Blanco	P01BNMOAST-A
2000	Silver	P01BNMOAST-B
2000	Chrome / Cromo	P01BNMOAST-K
2000	Gold / Dorado	P01BNMOAST-O

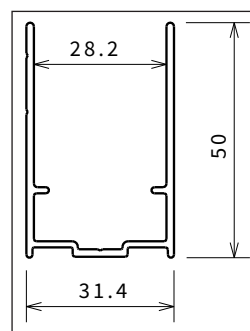

COMPENSATORY / COMPENSADORES

Height Altura	Profile Color perfil	Code Código
1984	White / Blanco	P05Y2ST-A
1984	Silver	P05Y2ST-B
1984	Chrome / Cromo	P05Y2ST-K
1984	Gold / Dorado	P05Y2ST-O
2000	White / Blanco	P05Y2ST2-A
2000	Silver	P05Y2ST2-B
2000	Chrome / Cromo	P05Y2ST2-K
2000	Gold / Dorado	P05Y2ST2-O

HOW TO TAKE THE MEASUREMENT / TOMA DE MEDIDAS

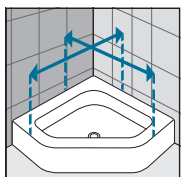
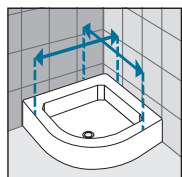
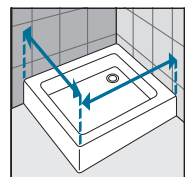

Take the measurements from wall to the external edge of the shower tray. Dimensions must be taken once the walls are finished and tiled, according to the above drawings.

Tomar las medidas desde la pared hasta el borde externo del plato de ducha.

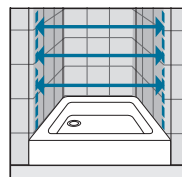

Take the measurements from wall to wall at the bottom, at the top, in the middle and use the smallest. Dimensions must be taken once the walls are finished and tiled, according to the above drawings.

Tomar medidas de pared a pared, medir la parte baja, la central y la superior. Cursar el pedido con la medida más pequeña.

YOUNG 2.0

Less profiles for a clear and essential look. Easy cleaning.

Los perfiles ceden el protagonismo al cristal.

Estética minimalista y comodidad para el día a día.

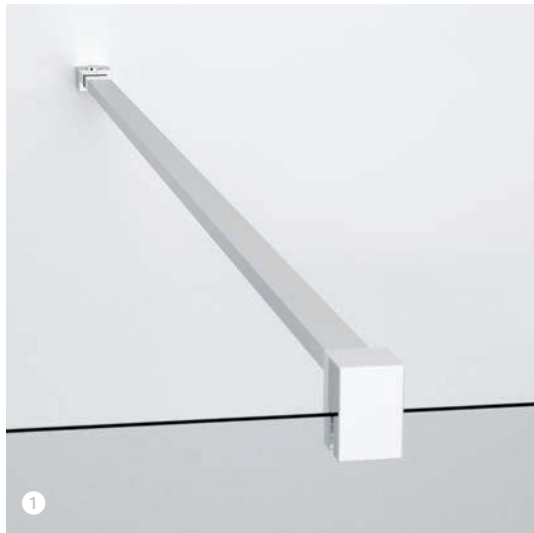

- ① New support bar / Nueva barra de sujeción a pared
- ② Chromed metal handle. / Tirador metálico cromo
- ③ Self Rising Hinges / Bisagra con sistema de autoelevación
- ④ In / Out opening of the door. / Sistemas de apertura interior / exterior

TREATMENT / TRATAMIENTOS



CRYSTAL CLEAR TREATMENT

Leaves glass easy to clean. Does not support the growth of bacteria and scale.

Only on transparent glass

TRATAMIENTO ANTIGOTAS

Dificulta la formación de gotas calcáreas. Cristaleses y perfiles siempre brillantes. Fácil de limpiar.

Sólo en cristal transparente.



PVD CHROME AND GOLD FINISH

Zero emission integrated cycle, 100% environment-friendly. Antiscale, antibacteria, ecological, long-time shining resistance.

ACABADO CROMO Y DORADO PVD

Ciclo de producción integrado sin emisiones, 100% ecológico. Anticalcáreo, Antibacterias, Ecológico. Brillo resistente y duradero.

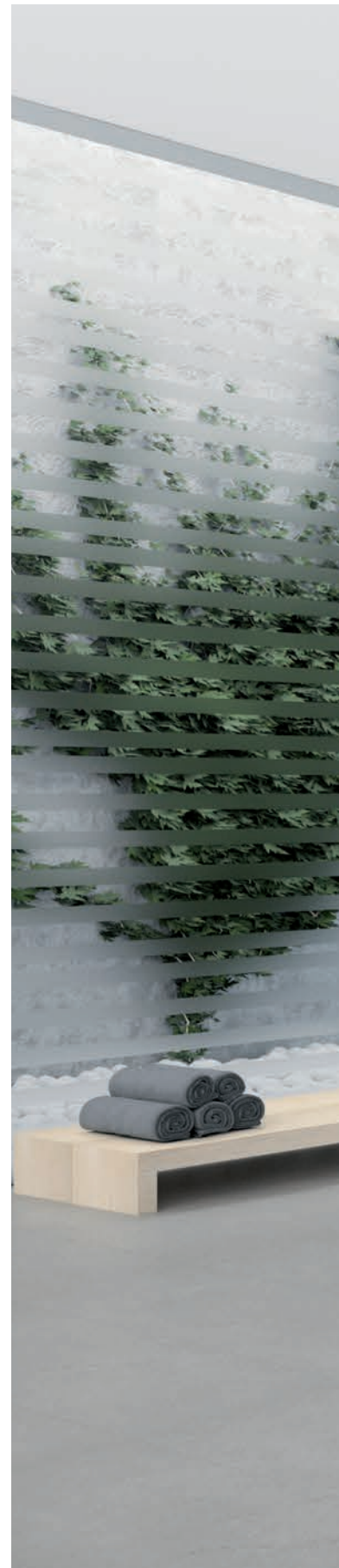

YOUNG 2.0 R2



200 cm



6 mm



2 cm



p. 47

QUADRANT SHOWER ENCLOSURE, 2 HINGED DOORS + 2 FIXED PANELS

MAMPARA SEMICIRCULAR DE DOS PUERTAS ABATIBLES + DOS FIJOS

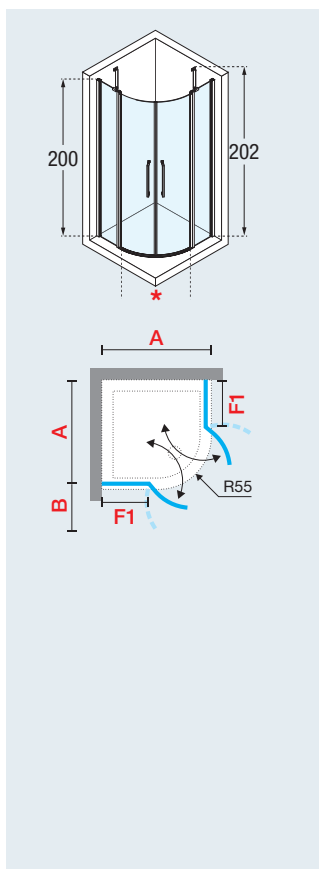

Dimensions Medidas				Code Código	Glass Cristales			Profile type / Price Perfiles / Precio			
Actual dimensions Extensibilidad		Access Entrada	Projection Espacio de apertura		1	2	4	D	B	K	O
A	F1	*	B		Clear Transparente	Aqua	Satin Satinado	White Blanco	Silver	Chrome Cromo	Gold Dorado
77,5 ↔ 79,5	22	71	38	Y2 R 80-							
87,5 ↔ 89,5	32	71	38	Y2 R 90-							
97,5 ↔ 99,5	42	71	38	Y2 R 100-							

HOW TO CHOOSE YOUR PRODUCT USING THE CODES:
EJEMPLO DE CÓDIGO:

Y2R80-1D = Y2R80- + 1 + D



OPTIONAL / OPCIONAL



Support bar
Barra estabilizadora en ángulo

Dimensions <i>Medidas</i>	Code <i>Código</i>	Price / <i>Precio</i>	
		Chrome <i>Cromo</i>	Gold <i>Dorado</i>
		K	O
15 cm	R80LOU150-		
25 cm	R80LOU250-		
35 cm	R80LOU350-		
45 cm	R80LOU450-		

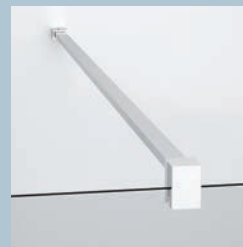

Support bar 150 cm length
Barra de sujeción 150 cm

Profile <i>Color perfil</i>	Code <i>Código</i>	Price <i>Precio</i>
White <i>Blanco</i>	R80Y215-D	
Silver	R80Y215-B	
Chrome <i>Cromo</i>	R80Y215-K	
Gold <i>Dorado</i>	R80Y215-O	



Adjustable bar kit

- 1 adjustable bar of 100 cm (shortened)
- wall attachment
- 1 glass clamp

Kit barra orientable

- Barra de 100 cms
- Pieza sujeción a muro
- Pieza de fijación al cristal

Profile <i>Color perfil</i>	Code <i>Código</i>	Price <i>Precio</i>
White <i>Blanco</i>	R80KUOR100-D	
Silver	R80KUOR100-B	
Chrome <i>Cromo</i>	R80KUOR100-K	



"T" bar kit

support bar of 150 cm to match with the supplied bar for T solution

Kit de barra en "T"

barra de sujeción de 150 cm para instalación en "T"

Profile <i>Color perfil</i>	Code <i>Código</i>	Price <i>Precio</i>
White <i>Blanco</i>	R80Y215T-D	
Silver	R80Y215T-B	
Chrome <i>Cromo</i>	R80Y215T-K	
Gold <i>Dorado</i>	R80Y215T-O	

TECHNICAL DATA / DATOS TÉCNICOS

GLASS TYPES / CRISTAL (EUROPEAN STANDARDS UNI EN 14428)



Clear
Transparente
COD. 1



Aqua
COD. 2

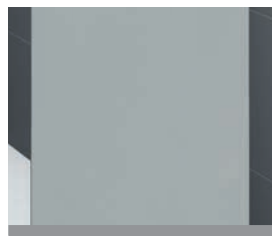

Satin
Satinado
COD. 4

PRINTING / SERIGRAFIA

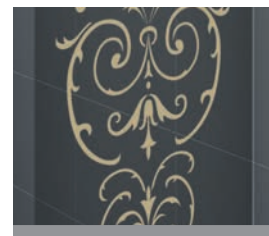

Victoriana Gold
Victoriana Dorado
COD. 72

(only for / solo para 2G, G+F, 1B, R2 LUX)

PROFILE COLOURS / COLORES PERFILES



White
Blanco
COD. D



Silver
COD. B



Chrome
Cromo
COD. K

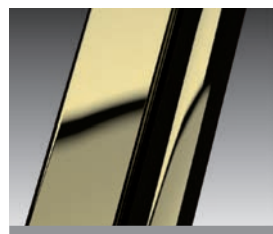

Gold
Dorado
COD. O



(only for / solo para 2G, G+F, 2A, 2B, F2B, G+F in line / en línea, 1B, F1B, A, R, R2, R1 SWIM, R2 LUX)

HANDLES / TIRADOR



Chromed metal handles
Tirador cromo
Interaxis 384mm
Medida entre agujeros de 384 mm

OVERALL DIMENSIONS FIXING PROFILES / MEDIDAS QUE OCUPAN LOS PERFILES EN LA PARED

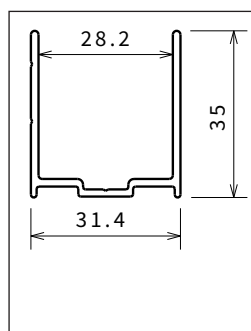

WALL / A PARED

Height Altura	Profile Color perfil	Code Código
1984	White / Blanco	P01BNMOBST-A
1984	Silver	P01BNMOBST-B
1984	Chrome / Cromo	P01BNMOBST-K
1984	Gold / Dorado	P01BNMOBST-O
2000	White / Blanco	P01BNMOAST-A
2000	Silver	P01BNMOAST-B
2000	Chrome / Cromo	P01BNMOAST-K
2000	Gold / Dorado	P01BNMOAST-O

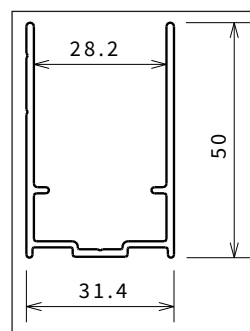

COMPENSATORY / COMPENSADORES

Height Altura	Profile Color perfil	Code Código
1984	White / Blanco	P05Y2ST-A
1984	Silver	P05Y2ST-B
1984	Chrome / Cromo	P05Y2ST-K
1984	Gold / Dorado	P05Y2ST-O
2000	White / Blanco	P05Y2ST2-A
2000	Silver	P05Y2ST2-B
2000	Chrome / Cromo	P05Y2ST2-K
2000	Gold / Dorado	P05Y2ST2-O

HOW TO TAKE THE MEASUREMENT / TOMA DE MEDIDAS

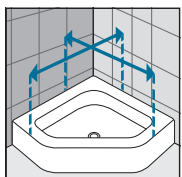
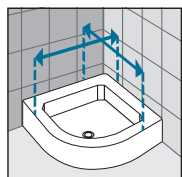
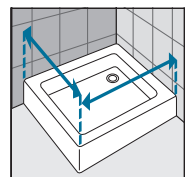

Take the measurements from wall to the external edge of the shower tray. Dimensions must be taken once the walls are finished and tiled, according to the above drawings.

Tomar las medidas desde la pared hasta el borde externo del plato de ducha.

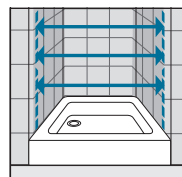

Take the measurements from wall to wall at the bottom, at the top, in the middle and use the smallest. Dimensions must be taken once the walls are finished and tiled, according to the above drawings.

Tomar medidas de pared a pared, medir la parte baja, la central y la superior. Cursar el pedido con la medida más pequeña.

YOUNG 2.0

Less profiles for a clear and essential look. Easy cleaning.

Los perfiles ceden el protagonismo al cristal.

Estética minimalista y comodidad para el día a día.

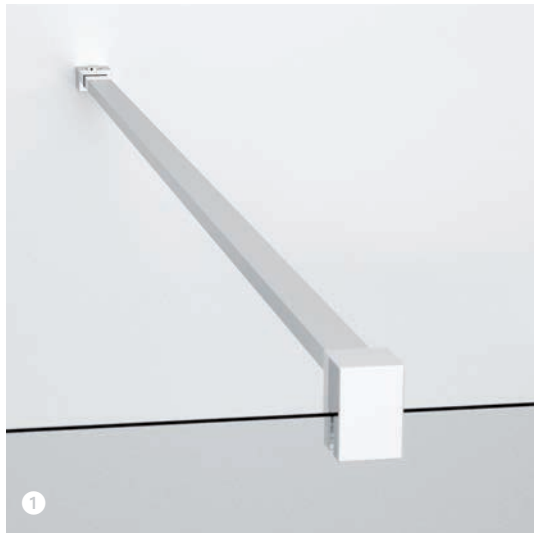

- 1 New support bar / Nueva barra de sujeción a pared
- 2 Chromed metal handle. / Tirador metálico cromo
- 3 Self Rising Hinges / Bisagra con sistema de autoelevación
- 4 In / Out opening of the door. / Sistemas de apertura interior / exterior

TREATMENT / TRATAMIENTOS



CRYSTAL CLEAR TREATMENT

Leaves glass easy to clean. Does not support the growth of bacteria and scale.

Only on transparent glass

TRATAMIENTO ANTIGOTAS

Dificulta la formación de gotas calcáreas. Cristaleses y perfiles siempre brillantes. Fácil de limpiar.

Sólo en cristal transparente.



PVD CHROME AND GOLD FINISH

Zero emission integrated cycle, 100% environment-friendly.

Antiscale, antibacteria, ecological, long-time shining resistance.

ACABADO CROMO Y DORADO PVD

Ciclo de producción integrado sin emisiones, 100% ecológico.

Anticalcáreo, Antibacterias, Ecológico. Brillo resistente y duradero.

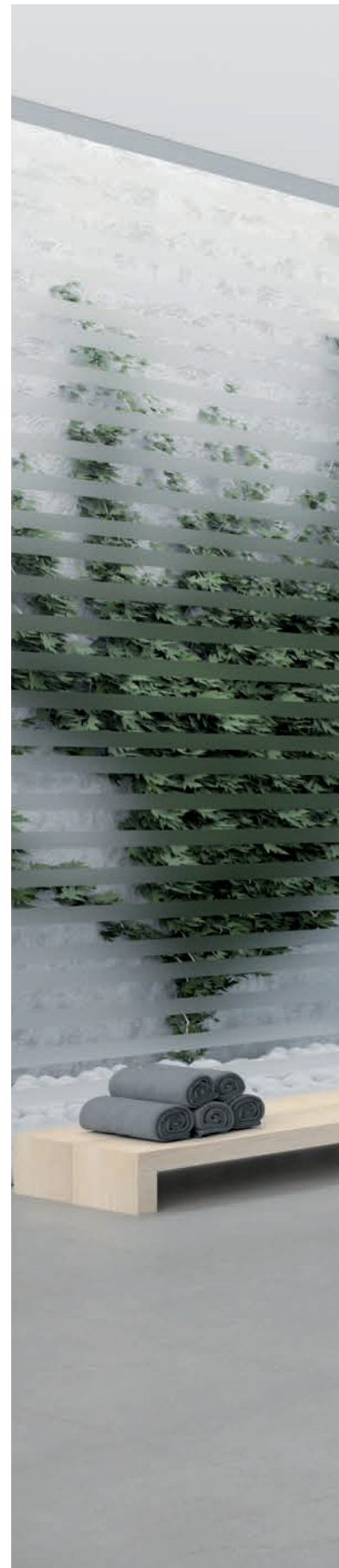

YOUNG 2.0 R2 LUX

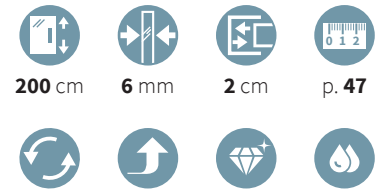

QUADRANT SHOWER ENCLOSURE, 2 HINGED DOORS
MAMPARA SEMICIRCULAR DE DOS PUERTAS ABATIBLES

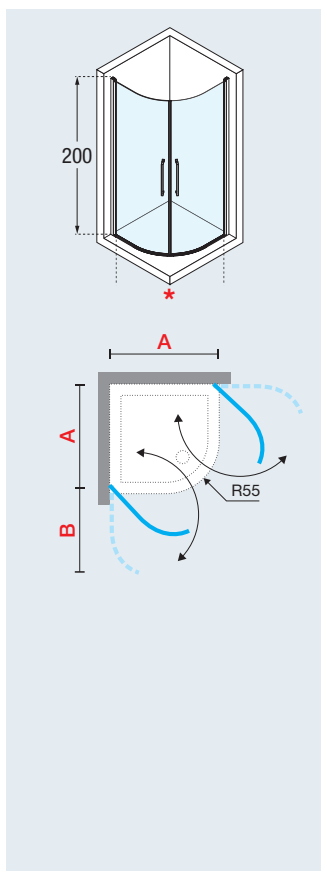

Dimensions Medidas			Code Código	Glass Cristales				Profile type / Price Perfiles / Precio			
Actual dimensions Extensibilidad	Access Entrada	Projection Espacio de apertura		1	2	4	72	D	B	K	O
A	*	B		Clear Transparente	Aqua	Satin Satinado	Victoriana Gold / Dorado	White Blanco	Silver	Chrome Cromo	Gold Dorado
77,5 ↔ 79,5	98	56	Y2 R2 80-	●							
87,5 ↔ 89,5	112	66	Y2 R2 90-	●							
97,5 ↔ 99,5	126	76	Y2 R2 100-	●							

HOW TO CHOOSE YOUR PRODUCT USING THE CODES:
EJEMPLO DE CÓDIGO:

Y2R280-1D = Y2R280- + 1 + D

● In stock - Delivery within 7 business days
Stock disponible - Entrega en un plazo máximo de 7 días



OPTIONAL / OPCIONAL



Support bar
Barra estabilizadora en ángulo

Dimensions <i>Medidas</i>	Code <i>Código</i>	Price / <i>Precio</i>	
		Chrome <i>Cromo</i>	Gold <i>Dorado</i>
15 cm	R80LOU150-	K	O
25 cm	R80LOU250-		
35 cm	R80LOU350-		
45 cm	R80LOU450-		

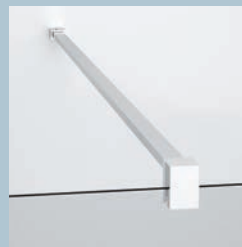

Support bar 150 cm length
Barra de sujeción 150 cm

Profile <i>Color perfil</i>	Code <i>Código</i>	Price <i>Precio</i>
White <i>Blanco</i>	R80Y215-D	
Silver	R80Y215-B	
Chrome <i>Cromo</i>	R80Y215-K	
Gold <i>Dorado</i>	R80Y215-O	



Adjustable bar kit

- 1 adjustable bar of 100 cm (shortened)
- wall attachment
- 1 glass clamp

Kit barra orientable

- Barra de 100 cms
- Pieza sujeción a muro
- Pieza de fijación al cristal

Profile <i>Color perfil</i>	Code <i>Código</i>	Price <i>Precio</i>
White <i>Blanco</i>	R80KUOR100-D	
Silver	R80KUOR100-B	
Chrome <i>Cromo</i>	R80KUOR100-K	



"T" bar kit

support bar of 150 cm to match with the supplied bar for T solution

Kit de barra en "T"

barra de sujeción de 150 cm para instalación en "T"

Profile <i>Color perfil</i>	Code <i>Código</i>	Price <i>Precio</i>
White <i>Blanco</i>	R80Y215T-D	
Silver	R80Y215T-B	
Chrome <i>Cromo</i>	R80Y215T-K	
Gold <i>Dorado</i>	R80Y215T-O	

TECHNICAL DATA / DATOS TÉCNICOS

GLASS TYPES / CRISTAL (EUROPEAN STANDARDS UNI EN 14428)

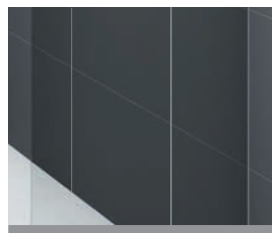

Clear
Transparente
COD. 1



Aqua
COD. 2

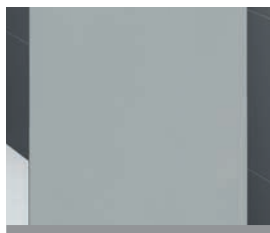

Satin
Satinado
COD. 4

PRINTING / SERIGRAFIA

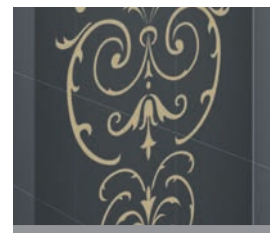

Victoriana Gold
Victoriana Dorado
COD. 72

(only for / solo para 2G, G+F, 1B, R2 LUX)

PROFILE COLOURS / COLORES PERFILES



White
Blanco
COD. D



Silver
COD. B



Chrome
Cromo
COD. K

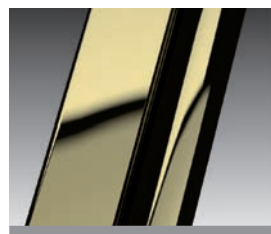

Gold
Dorado
COD. O



(only for / solo para 2G, G+F, 2A, 2B, F2B, G+F in line / en línea, 1B, F1B, A, R, R2, R1 SWIM, R2 LUX)

HANDLES / TIRADOR



Chromed metal handles
Tirador cromo
Interaxis 384mm
Medida entre agujeros de 384 mm

OVERALL DIMENSIONS FIXING PROFILES / MEDIDAS QUE OCUPAN LOS PERFILES EN LA PARED

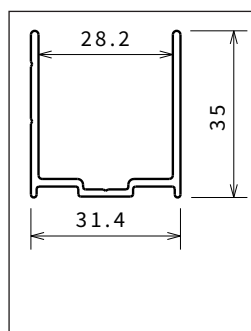

WALL / A PARED

Height Altura	Profile Color perfil	Code Código
1984	White / Blanco	P01BNMOBST-A
1984	Silver	P01BNMOBST-B
1984	Chrome / Cromo	P01BNMOBST-K
1984	Gold / Dorado	P01BNMOBST-O
2000	White / Blanco	P01BNMOAST-A
2000	Silver	P01BNMOAST-B
2000	Chrome / Cromo	P01BNMOAST-K
2000	Gold / Dorado	P01BNMOAST-O

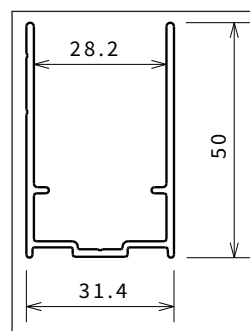

COMPENSATORY / COMPENSADORES

Height Altura	Profile Color perfil	Code Código
1984	White / Blanco	P05Y2ST-A
1984	Silver	P05Y2ST-B
1984	Chrome / Cromo	P05Y2ST-K
1984	Gold / Dorado	P05Y2ST-O
2000	White / Blanco	P05Y2ST2-A
2000	Silver	P05Y2ST2-B
2000	Chrome / Cromo	P05Y2ST2-K
2000	Gold / Dorado	P05Y2ST2-O

HOW TO TAKE THE MEASUREMENT / TOMA DE MEDIDAS

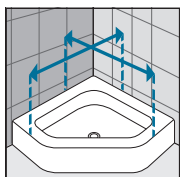
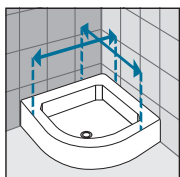
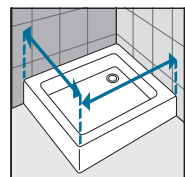

Take the measurements from wall to the external edge of the shower tray. Dimensions must be taken once the walls are finished and tiled, according to the above drawings.

Tomar las medidas desde la pared hasta el borde externo del plato de ducha.

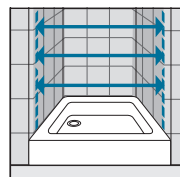

Take the measurements from wall to wall at the bottom, at the top, in the middle and use the smallest. Dimensions must be taken once the walls are finished and tiled, according to the above drawings.

Tomar medidas de pared a pared, medir la parte baja, la central y la superior. Cursar el pedido con la medida más pequeña.

YOUNG 2.0

Less profiles for a clear and essential look. Easy cleaning.

Los perfiles ceden el protagonismo al cristal.

Estética minimalista y comodidad para el día a día.

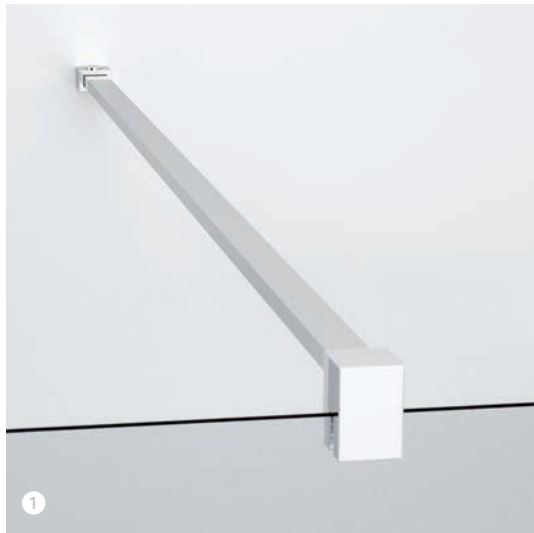

- ① New support bar / Nueva barra de sujeción a pared
- ② Chromed metal handle. / Tirador metálico cromo
- ③ Self Rising Hinges / Bisagra con sistema de autoelevación
- ④ In / Out opening of the door. / Sistemas de apertura interior / exterior

TREATMENT / TRATAMIENTOS



CRYSTAL CLEAR TREATMENT

Leaves glass easy to clean. Does not support the growth of bacteria and scale.

Only on transparent glass

TRATAMIENTO ANTIGOTAS

Dificulta la formación de gotas calcáreas. Cristaleses y perfiles siempre brillantes. Fácil de limpiar.

Sólo en cristal transparente.



PVD CHROME AND GOLD FINISH

Zero emission integrated cycle, 100% environment-friendly. Antiscaling, antibacterial, ecological, long-time shining resistance.

ACABADO CROMO Y DORADO PVD

Ciclo de producción integrado sin emisiones, 100% ecológico. Anticalcáreo, Antibacterias, Ecológico. Brillo resistente y duradero.



YOUNG 2.0 R1



200 cm



6 mm



2 cm



p. 47

QUADRANT SHOWER ENCLOSURE, 1 HINGED DOOR + 2 FIXED PANELS

MAMPARA SEMICIRCULAR DE UNA PUERTA ABATIBLE + DOS FIJOS

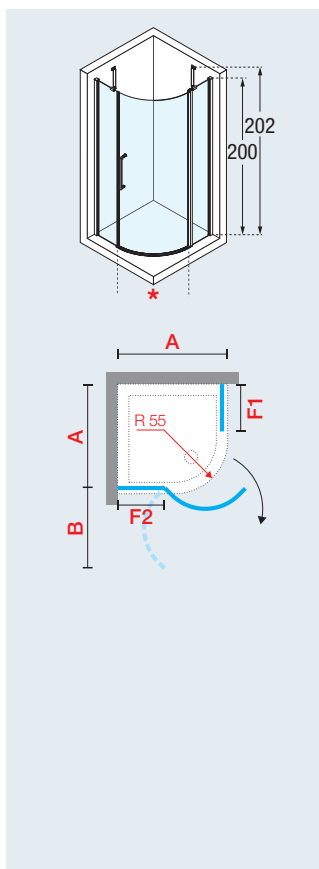

Dimensions Medidas					Code Código	Glass Cristales			Profile type / Price Perfiles / Precio			
Actual dimensions Extensibilidad		Access Entrada	Projection Espacio de apertura			1	2	4	D	B	K	O
A	F1	F2	*	B		Clear Transparente	Aqua	Satin Satinado	White Blanco	Silver	Chrome Cromo	Gold Dorado
77,5 ↔ 79,5	23	22	72	73	Y2 R1A 80-							
87,5 ↔ 89,5	33	32	72	73	Y2 R1A 90-							
97,5 ↔ 99,5	43	42	72	73	Y2 R1A 100-							

HOW TO CHOOSE YOUR PRODUCT USING THE CODES:
EJEMPLO DE CÓDIGO:

Y2R1A80-1D

=

Y2R1A80-

+





1

+

D

● In stock - Delivery within 7 business days
Stock disponible - Entrega en un plazo máximo de 7 días

YOUNG 2.0 R

 200 cm
  6 mm
  2 cm
  p. 47

OFF-SET QUADRANT SHOWER ENCLOSURE, 1 HINGED DOOR + 2 FIXED PANELS
MAMPARA SEMICIRCULAR DE UNA PUERTA ABATIBLE + DOS FIJOS.
PARA PLATO DE DUCHA SWIM

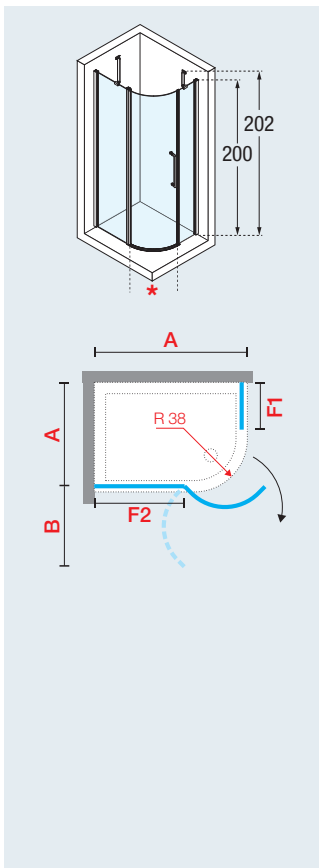

Dimensions Medidas					Code Código	Glass Cristales			Profile type / Price Perfiles / Precio			
Actual dimensions Extensibilidad	F1	F2	Access Entrada	Projection Espacio de apertura		1	2	4	D	B	K	O
A	F1	F2	*	B		Clear Transparente	Aqua	Satin Satinado	White Blanco	Silver	Chrome Cromo	Gold Dorado
67,5 ↔ 69,5 x 87,5 ↔ 89,5	30	49	48	49	Y2 R1A 7090-	●					■	
77,5 ↔ 79,5 x 97,5 ↔ 99,5	40	59	48	49	Y2 R1A 80100-	●					■	
77,5 ↔ 79,5 x 117,5 ↔ 119,5	40	79	48	49	Y2 R1A 80120-	●					■	

HOW TO CHOOSE YOUR PRODUCT USING THE CODES:
EJEMPLO DE CÓDIGO:

Y2R1A7090-1D = Y2R1A7090- + 1 + D

● In stock - Delivery within 7 business days
 Stock disponible - Entrega en un plazo máximo de 7 días



OPTIONAL / OPCIONAL



Support bar
Barra estabilizadora en ángulo

Dimensions <i>Medidas</i>	Code <i>Código</i>	Price / Precio	
		Chrome <i>Cromo</i>	Gold <i>Dorado</i>
15 cm	R80LOU150-	K	O
25 cm	R80LOU250-		
35 cm	R80LOU350-		
45 cm	R80LOU450-		

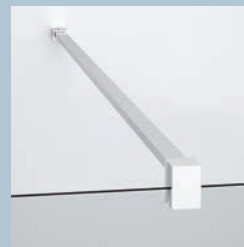

Support bar 150 cm length
Barra de sujeción 150 cm

Profile <i>Color perfil</i>	Code <i>Código</i>	Price <i>Precio</i>
White <i>Blanco</i>	R80Y215-D	
Silver	R80Y215-B	
Chrome <i>Cromo</i>	R80Y215-K	
Gold <i>Dorado</i>	R80Y215-O	



Adjustable bar kit

- 1 adjustable bar of 100 cm (shortened)
- wall attachment
- 1 glass clamp

Kit barra orientable

- Barra de 100 cms
- Pieza sujeción a muro
- Pieza de fijación al cristal

Profile <i>Color perfil</i>	Code <i>Código</i>	Price <i>Precio</i>
White <i>Blanco</i>	R80KUOR100-D	
Silver	R80KUOR100-B	
Chrome <i>Cromo</i>	R80KUOR100-K	



"T" bar kit

support bar of 150 cm to match with the supplied bar for T solution

Kit de barra en "T"

barra de sujeción de 150 cm para instalación en "T"

Profile <i>Color perfil</i>	Code <i>Código</i>	Price <i>Precio</i>
White <i>Blanco</i>	R80Y215T-D	
Silver	R80Y215T-B	
Chrome <i>Cromo</i>	R80Y215T-K	
Gold <i>Dorado</i>	R80Y215T-O	

TECHNICAL DATA / DATOS TÉCNICOS

GLASS TYPES / CRISTAL (EUROPEAN STANDARDS UNI EN 14428)

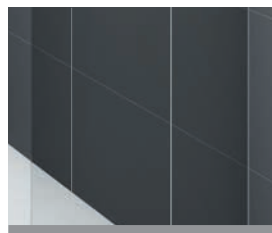

Clear
Transparente
COD. 1



Aqua
COD. 2

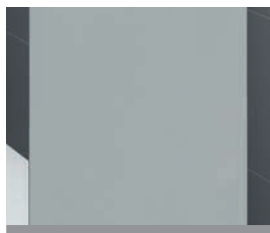

Satin
Satinado
COD. 4

PRINTING / SERIGRAFIA

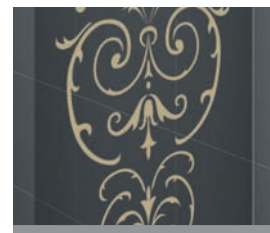

Victoriana Gold
Victoriana Dorado
COD. 72

(only for / solo para 2G, G+F, 1B, R2 LUX)

PROFILE COLOURS / COLORES PERFILES



White
Blanco
COD. D



Silver
COD. B



Chrome
Cromo
COD. K

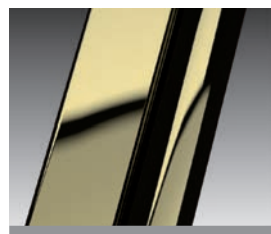

Gold
Dorado
COD. O



(only for / solo para 2G, G+F, 2A, 2B, F2B, G+F in line / en línea, 1B, F1B, A, R, R2, R1 SWIM, R2 LUX)

HANDLES / TIRADOR



Chromed metal handles
Tirador cromo
Interaxis 384mm
Medida entre agujeros de 384 mm

OVERALL DIMENSIONS FIXING PROFILES / MEDIDAS QUE OCUPAN LOS PERFILES EN LA PARED

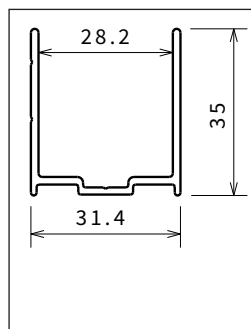

WALL / A PARED

Height Altura	Profile Color perfil	Code Código
1984	White / Blanco	P01BNMOBST-A
1984	Silver	P01BNMOBST-B
1984	Chrome / Cromo	P01BNMOBST-K
1984	Gold / Dorado	P01BNMOBST-O
2000	White / Blanco	P01BNMOAST-A
2000	Silver	P01BNMOAST-B
2000	Chrome / Cromo	P01BNMOAST-K
2000	Gold / Dorado	P01BNMOAST-O

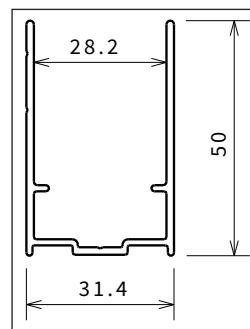

COMPENSATORY / COMPENSADORES

Height Altura	Profile Color perfil	Code Código
1984	White / Blanco	P05Y2ST-A
1984	Silver	P05Y2ST-B
1984	Chrome / Cromo	P05Y2ST-K
1984	Gold / Dorado	P05Y2ST-O
2000	White / Blanco	P05Y2ST2-A
2000	Silver	P05Y2ST2-B
2000	Chrome / Cromo	P05Y2ST2-K
2000	Gold / Dorado	P05Y2ST2-O

HOW TO TAKE THE MEASUREMENT / TOMA DE MEDIDAS

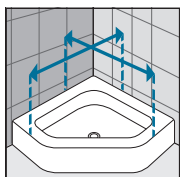
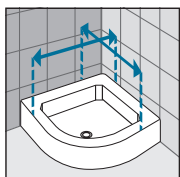
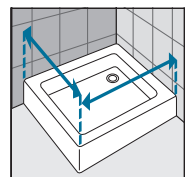

Take the measurements from wall to the external edge of the shower tray. Dimensions must be taken once the walls are finished and tiled, according to the above drawings.

Tomar las medidas desde la pared hasta el borde externo del plato de ducha.

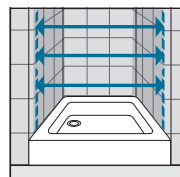

Take the measurements from wall to wall at the bottom, at the top, in the middle and use the smallest. Dimensions must be taken once the walls are finished and tiled, according to the above drawings.

Tomar medidas de pared a pared, medir la parte baja, la central y la superior. Cursar el pedido con la medida más pequeña.